

# 68K Turbine Blade Handling Interim Design



Team 14

Patrick Filan  
Clint Kainec  
John Kemp



# Advisors

## Industry

### Ashtok Patel

Industrial Engineer  
Environmental Health &  
Safety Manager at **TECT  
Power**  
CSP, CHMM

## Faculty

### Dr. Patrick Hollis

Associate Professor &  
Undergraduate Coordinator  
Department of Mechanical  
Engineering

### Dr. Kamal Amin

Professor  
Department of Mechanical  
Engineering

# TECT Power: Thomasville, GA

- A turbine part manufacturing facility
- Currently process a variety of turbine blades
  - Machining, finishing, testing
- Operates both single-axis manual mills and multi-axis automated mills



# The 68K Blade

- 45 lb
- 3ft x 1ft x 0.125in
- Titanium aluminide
- Received as a raw forging
  - Only basic geometry
- Geometry
  - Root
  - Tip
  - Twist
  - Midspan
- Used in 68K engines
  - Generate 68,000lbf thrust

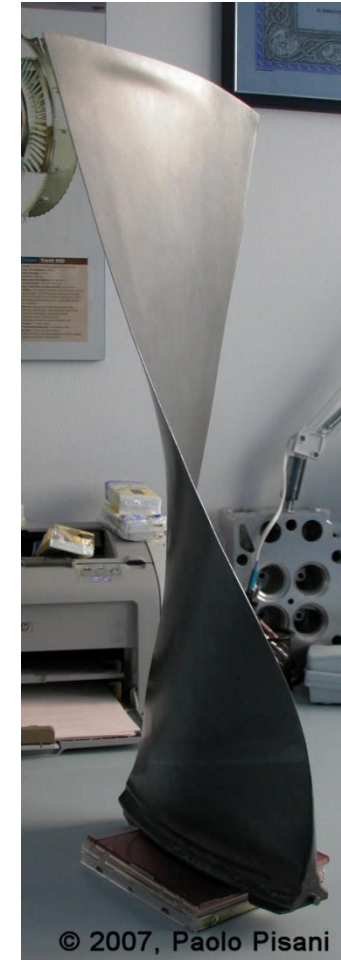

# The Problem

- Manual lifting of the 68K turbine blade
  - Risk of injury
  - Straining workers
  - Difficult for new workers
  - Needs to be eliminated
- The blade moves through several machines
  - Each machine unique
    - Obstructions
    - Placement
    - Orientation

# Blade Orientations

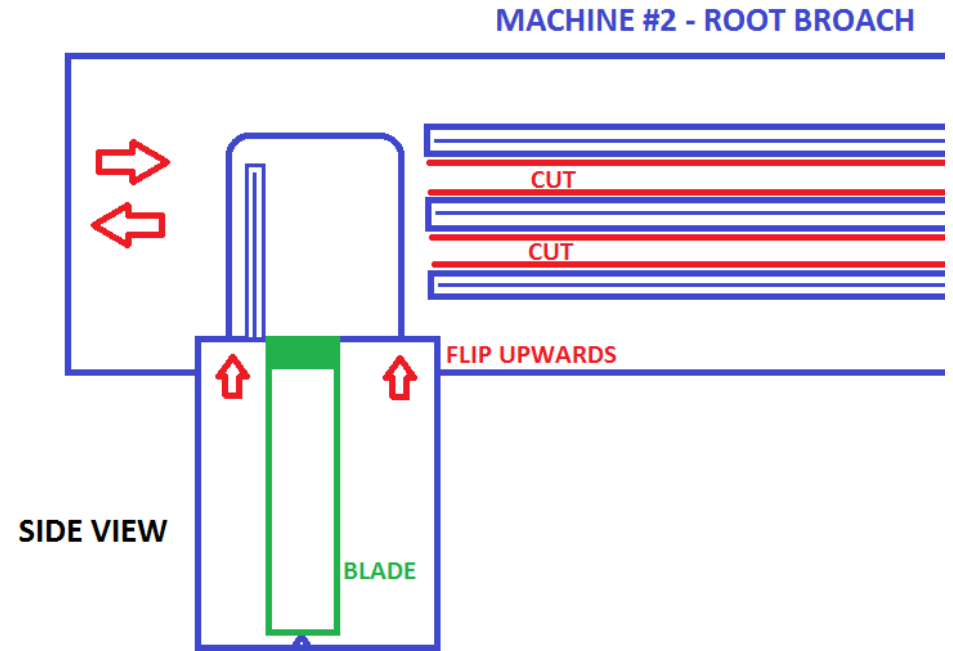
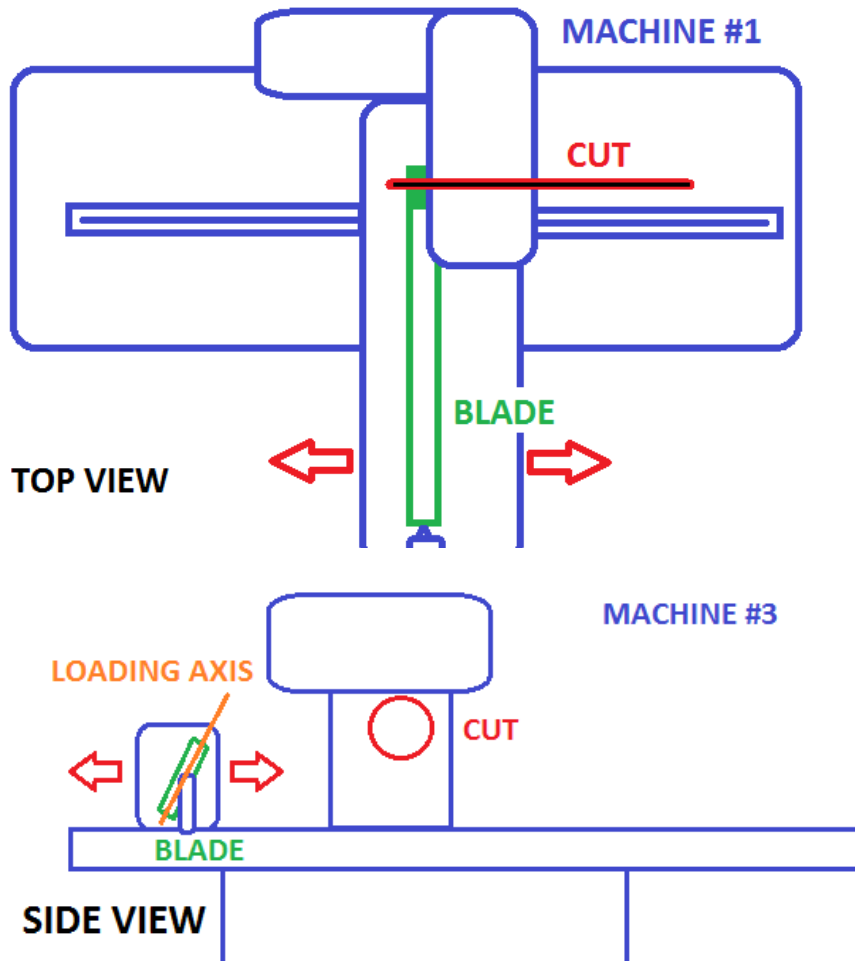

Machines 1-3 perform root operations on the blade

# Project Focus

- **Safety**
  - Ergonomics
  - Part-friendly
- Modify current cart
- Orientation and 3D position of the blade
  - Machine-friendly
    - Loading and unloading
  - Time efficiency
  - Cost effectiveness

# Existing Apparatus

## Previous Team

- Cart design
- Transport from storage to machine 1
- Orientated horizontally
- Many machines





# Modifications Necessary

- Removing shelves
  - Adding storage
- Attaching new apparatus
  - Crane
  - Grips
- Housing for apparatus parts
  - Electrical system – If applicable
  - Battery – If applicable

# Crane System

- Mechanical advantage
  - Pulley system
- Crane Motion Ability
- Motor Control
- Support Arms



# Crane System

- Pulley system
  - Machined pulley
  - 7/64<sup>th</sup> nylon rope
  - 1,200lbs tensile
- Removable shafts
  - Ease Access
- Bearings
  - High Pressure
  - Concealed
  - No maintenance

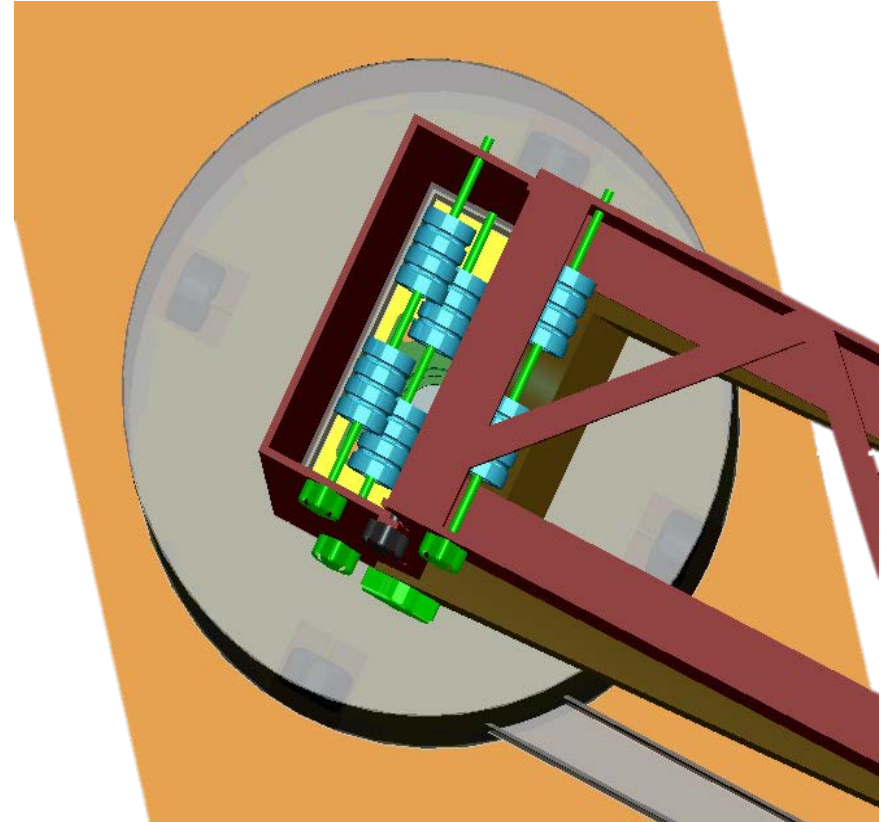

# Mobility

- Cart Motion
  - Vertical motion
  - Planer motion
- Apparatus Motion
  - Rotation
  - Crane motion
- Blade Motion
  - Vertical motion

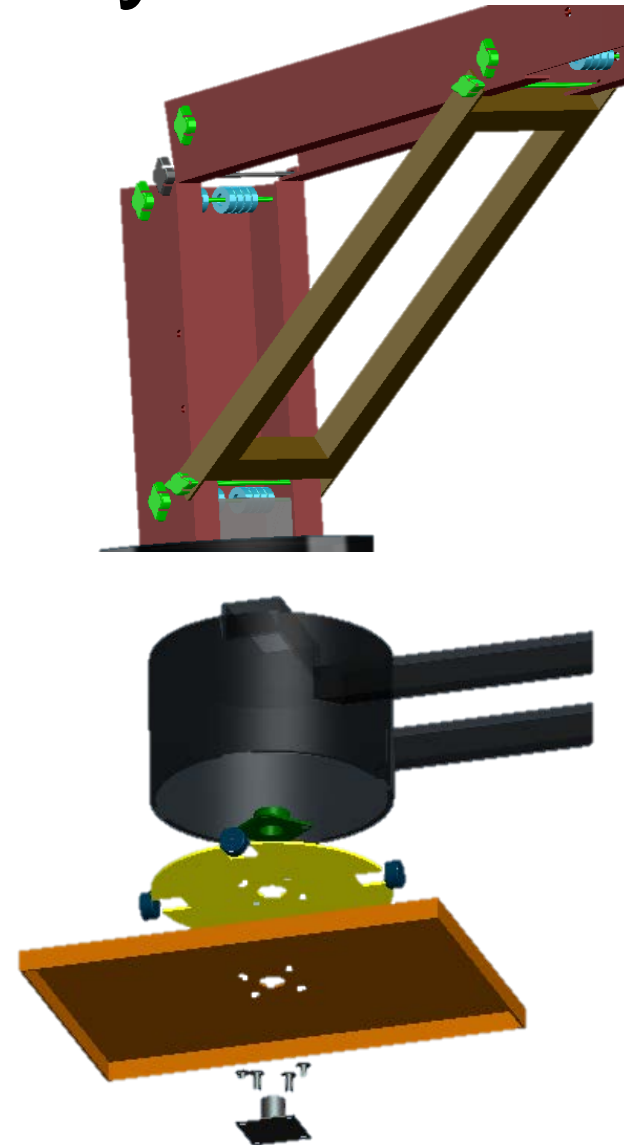

# Support Arms

- Purpose
  - Aide in blade orientation
- Dimensions
  - 5 feet long
  - 15 in apart
- Material
  - Steel
  - Thin, light
  - Durable

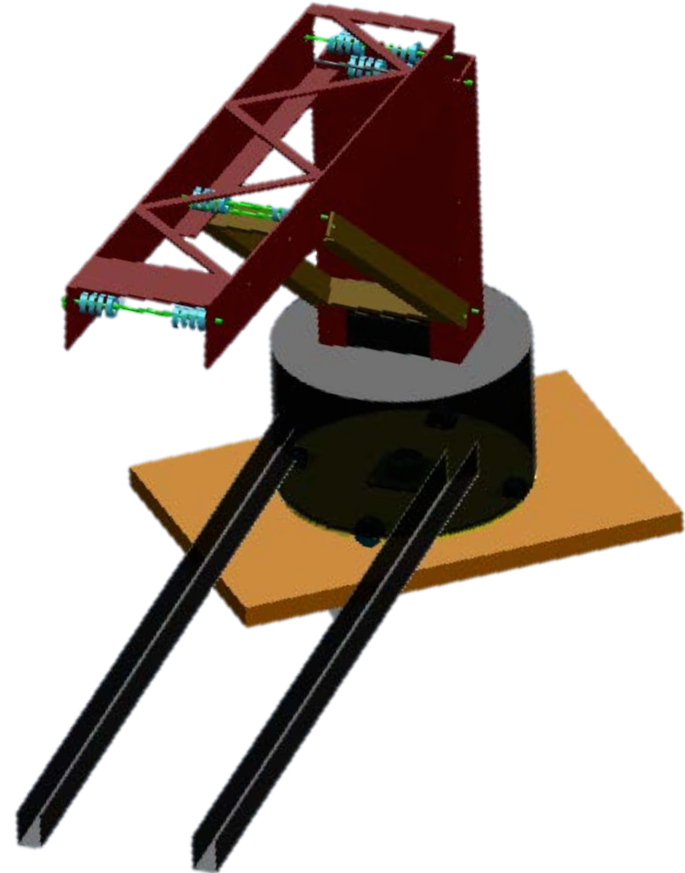

# Motor Control

- Two independent systems each equip with
  - 2 0.75hp motor
  - 2 12V batteries
  - 6 Pulleys
  - Spool
- Concealed within a housing

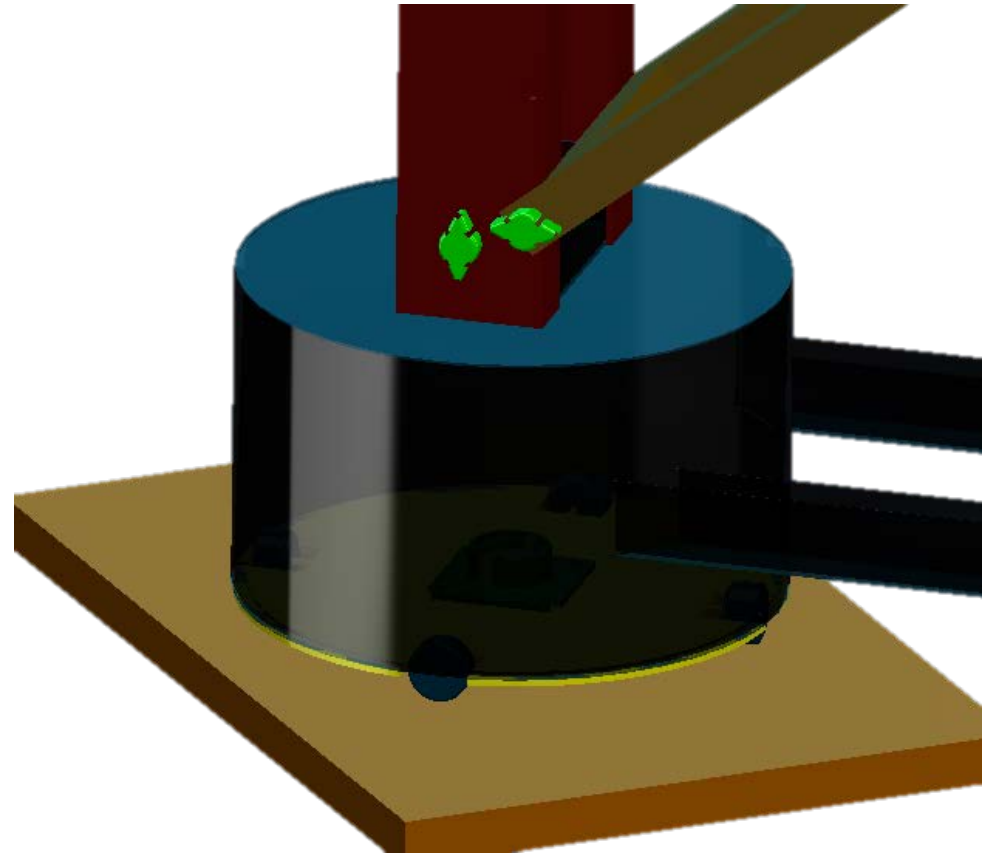

# Design: Electrical

- Need motor driven system
  - Mechanical system too slow
- Need two 12V batteries
- Need controller
- Need power supply
  - Charge and scale voltage
- Motor specifications
  - 0.75hp
  - 12/24VDC
  - Variable speed settings
    - Requested by TECT



# Design: Blade Harness

- Modeled after climbing harness
  - Fits geometry of the blade (midspan)
- Holds the blade
  - Clipping positions
    - Loops and carabineers
- Materials
  - Nylon webbing
  - Heavy thread
  - Leather wear strips





# Safety

## Hazards

- Large structure
  - Movement hazard
  - Difficult to maneuver in tight spaces
  - Heavy

## Resolved issues

- Power supply
  - Battery-powered
    - Detachable cord
- Unattended movement
  - Movement locks
    - Feet on base of cart
    - Locking pins on moving parts
  - Tipping
    - Support struts

# Questions?



# References

- Amend, John. "Sandbagged robotics." 12 January 2011. *Through the Sand and Glass*. Image. October 2012.
- Ashby, M. F. *Multi-objective optimization in material design and selection*. Cambridge, UK, n.d. Image. 28 October 2012. <<http://www.sciencedirect.com/science/article/pii/S1359645499003043>>.
- Newton, Jason, et al. "TECT." n.d. *Team 9*. October 2012. <[http://eng.fsu.edu/me/senior\\_design/2012/team9/](http://eng.fsu.edu/me/senior_design/2012/team9/)>.
- "Spring 2006 Issue 01." n.d. *Robot Magazine*. Image. October 2012. <<http://www.botmag.com/issue2/images/bottom2.jpg>>.
- "The Parish of St. Cuthbert with St. Aidan." n.d. Image. 20 October 2012. <[http://www.stcuthbertwithstaidan.org.uk/images/IMG\\_0721.jpg](http://www.stcuthbertwithstaidan.org.uk/images/IMG_0721.jpg)>.
- <<http://www.sciencenewsforkids.org/2010/11/coffee-gives-robots-a-grip/>>.
- <<http://gizmodo.com/5419292/geeky-gifts-whose-proceeds-go-to-charity/gallery/1>>.
- <<http://www.enginehistory.org/GasTurbines/Blades/blades.shtml>>.
- <<http://www.pexsupply.com/Rheem-51-103823-01-1-HP-Variable-Speed-Motor-208-230V?gclid=CL2cu-u2zLMCFQq0nQod9XQAkw>>.