

Operations Manual: Lidar Cave Mapper

Senior Design Fall 2016/Spring2017

Created by:

Spencer Day

Hunter Hayden

Alisha Hunt

Jake Ogburn

James Oliveros

Cesar Rivas

Executive Summary

Using LiDAR, professional cavers and researchers have mapped caves in three dimensions for years. This process and the equipment needed is generally very expensive and not available to the average person. With a LiDAR Cave Mapper anyone can now take a hike into a cave, place the device, run it, and ultimately have a 3D point cloud image of the cave.

The LiDAR device sends out lasers and records the time it takes for them to return back to the device. In order to map a cave, the LiDAR will be rotated 180 degrees on its base, and 270 degrees over its center. This ensures the LiDAR “sees” the entire surrounding cave except the floor beneath it. The data recorded is saved on an SD card that can be transported to the users computer. This data, distance and direction, can then be uploaded into a software that places a point at each location, building the cave.

The LiDAR Cave Mapper has been designed so that it is easy to setup, and easy to operate. The user simply attaches the battery to provide power to the two stepper motors, places the 3D printed mount on the provided tripod, switches the system on, and leaves it to run alone in the cave. After the LiDAR has finished a full 360 degree scan of its surroundings, the information can be uploaded onto the user’s computer to create a 3D map of the previously scanned cave.

This system is very portable, user friendly, accurate, and inexpensive. It can be enjoyed by amateur cavers, hikers, outdoorsman and families alike.

Contents

Executive Summary	2
Components	4
Mechanical Components	4
Electrical Components.....	5
LEDs.....	5
Power Sonic PS – 1270 F2 Battery	5
Buck Converter	7
NEMA 8 Stepper Motor.....	7
Pancake Stepper Motor	8
Stepper Motor EZ Driver	8
Arduino Mega 2560	9
Garmin Lidar Lite V3.....	9
LSM9DS1 Inertial Measurement Unit.....	10
Micro SD Shield.....	11
Setup.....	12
Mechanical Setup	12
Electrical Setup.....	12
Deconstruction and Storage.....	13
Libraries.....	13
Operation.....	13
Troubleshooting	15
Wiring and Signal Problems	15
Slipping	15
Sticking.....	15
Uploads.....	15
Changing Hardware	15
Appendix	16

Components

Mechanical Components

There are very few mechanical components that were needed to complete this project. The bulk of the structure was 3D printed from CAD models. The .stl files for these pieces can be found on the project website. A detailed layout of the structure and the 3D printed parts can be found in the mechanical setup section. Apart from the parts that were printed, the only parts that were needed were couplers, shafts, a tripod and a lazy susan, which is essentially two plastic plates separated by ball bearings so that whatever rests on top of it may rotate freely.



Figure 2: 5mm shaft coupler

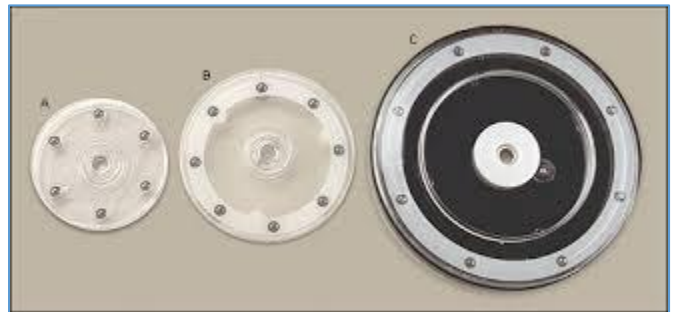

Figure 1: Lazy susan bearing

Electrical Components

LEDs



Figure 3: LEDs

There are three LEDs used in the cave mapping system to display operating modes. A solid yellow light represents the device is supplied power. If the yellow LED does not illuminate when power is turned on, refer to the troubleshooting portion of this manual. Once power is on and a scan is initiated, a blinking yellow light will indicate that a scan is in progress. When the scan is complete a solid green light will be illuminate. If an error has occurred during the scan a sold red LED will illuminate. If the red LED turns on, refer to the troubleshooting portion of this manual.

Power Sonic PS – 1270 F2 Battery



Figure 4: Power Sonic PS – 1270 F2 Battery

The Power Sonic PS – 1270 F2 Battery is a small rechargeable 12 V lead acid battery capable of powering the system for at least two target areas. The power flows through a buck converter to the Arduino Mega 2560 and each EZ Driver. Different batteries may be used however other component manipulation may be required.

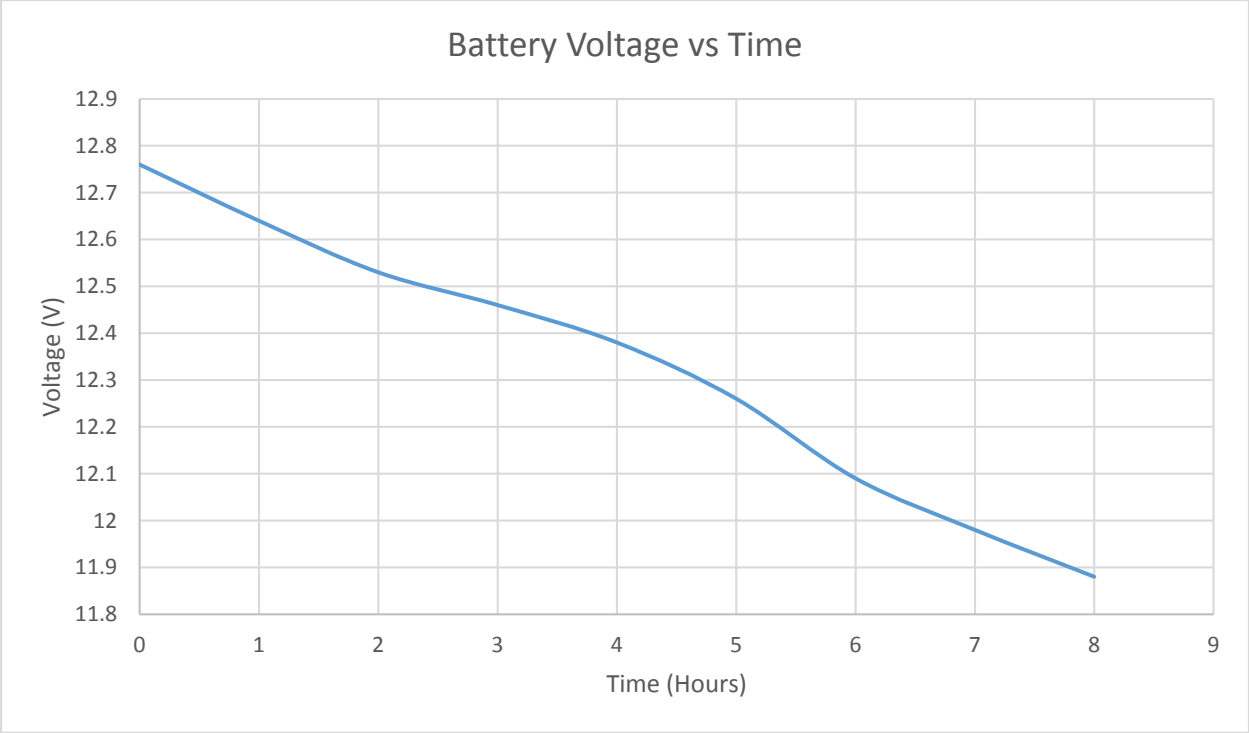

Figure 5: Battery Testing

Time (hr)	Battery Voltage (V)	Buck Converter (V)	5V Output	3.3 V Output
0	12.76	9.03	5.1	3.3
1	12.64	9.03	5.1	3.3
2	12.53	9.03	5.1	3.3
3	12.46	9.03	5.1	3.3
4	12.38	9.03	5.1	3.3
5	12.26	9.03	5.1	3.3
6	12.06	9.03	5.1	3.3
7	11.98	9.03	5.1	3.3
8	11.88	9.03	5.1	3.3

Buck Converter

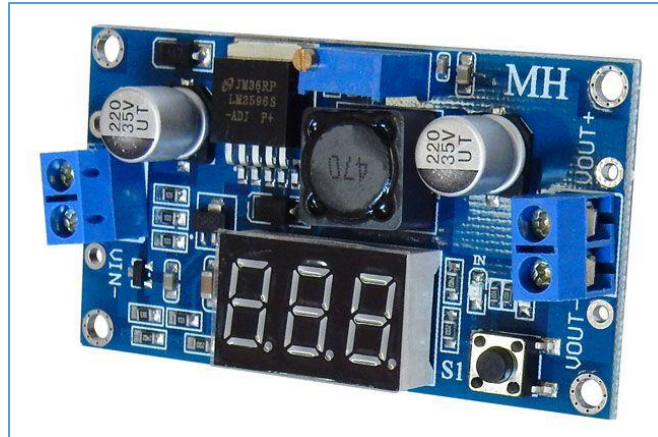

Figure 6: Buck Converter

A buck converter is used to step down a higher voltage to a lower voltage that can be used by other electronics. The converter steps down 12V from the battery to 9V to supply power to both EZ Drivers and the Arduino Mega 2560. The output voltage can be adjusted by a set screw. The buck converter has a built in button that excites power flow. This acts as the power button for the system.

NEMA 8 Stepper Motor



Figure 7: NEMA 8 Stepper Motor

The NEMA 8 stepper motor is a small, smooth bipolar motor that controls the vertical motion of the Lidar Lite and the IMU. It receives power and is controlled by an EZ Driver that manipulates the step size based on the scanning mode.

Pancake Stepper Motor

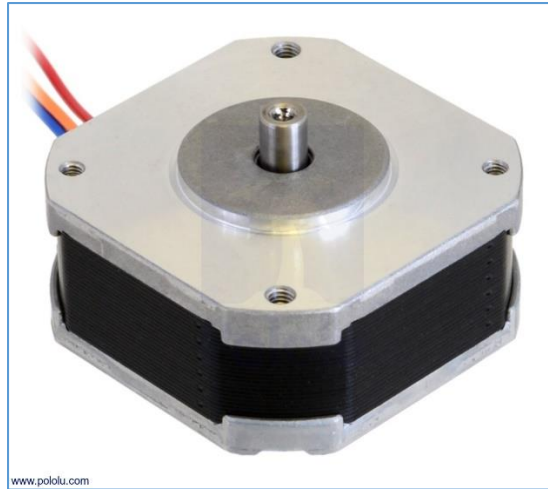

Figure 8: Pancake Stepper Motor

The Sanyo Pancake Stepper Motor is a thin, high torque bipolar motor that controls the rotation of the base of the device. It receives power and is controlled by an EZ Driver that ensures a smooth rotation.

Stepper Motor EZ Driver

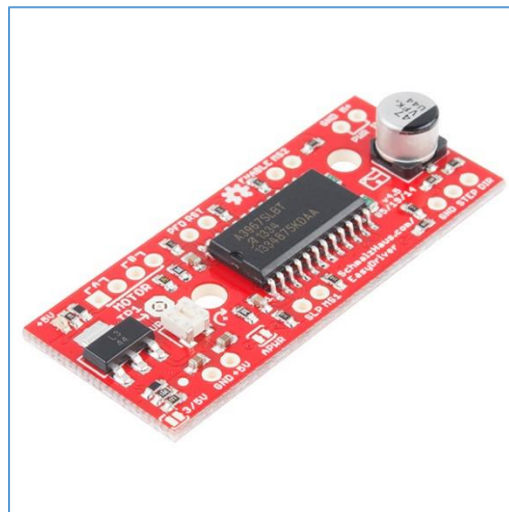

Figure 9: Stepper Motor EZ Driver

WARNING: DO NOT CONNCT OR DISCONNECT A MOTOR WHEN THE EZ DRIVER IS ENERGIZED. MAY RESULT IN A DAMAGED EZ DRIVER.

The EZ Driver is a simple stepper motor driver that allows total control over any bipolar stepper motor. The driver is supplied 9V from the buck converted and has a built in voltage regulator that ensures the proper voltage to the motor. A set current is allowed to flow to each coil and can

be adjusted by a set screw. The rotational direction and step size can be manipulated by the EZ Driver.

Arduino Mega 2560

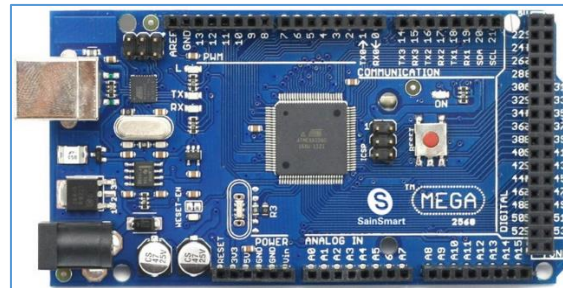

Figure 10:Arduino Mega 2560

The Arduino Mega 2560 is a microcontroller capable of controlling the following electronics. It harnesses the uploaded code to run the system autonomously after initial set up. It is supplied 9V from the buck converter to operate. In addition to interfacing with components, the onboard 5V and 3.3V power supply provide power to the Lidar Lite V3 and the IMU. There are many unused pins available for users to add additional components, however other component manipulation may be required.

Garmin Lidar Lite V3



Figure 11:Garmin Lidar Lite V3

WARNING: DO NOT MAKE DIRECT EYE CONTACT WITH LASER. SEVERE INJURY CAN OCCUR.

The Garmin Lidar Lite V3 is a high resolution laser range finder. It operates by sending out a pulse of light and waiting for it to return. The total time of the returned signal is used in calculations to evaluate the distance. The Lidar lite can also return the percent of reflective light for each reading. It is supplied 5 V from the Arduino Mega and consumes 130 mA in continuous mode. The user can configure the device to adjust accuracy, operating range, and measurement

time. Tests over an hour show the device is reliable when running for long periods of time. As shown in the following chart, the LiDAR consistently measures a fixed distance over the course of an hour. The moving average is shown.

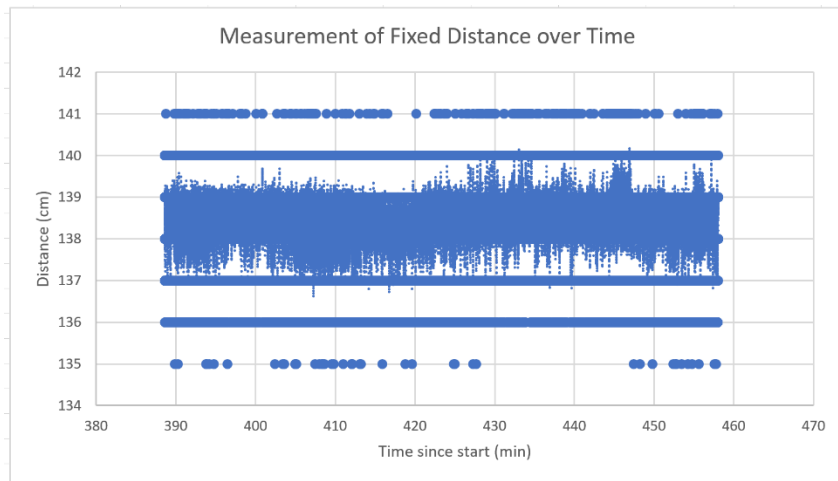

Figure 12: LIDAR testing

LSM9DS1 Inertial Measurement Unit

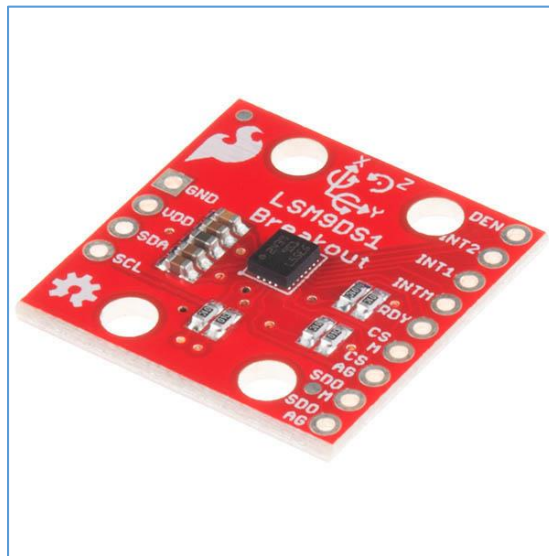

Figure 13: LSM9DS1 Inertial Measurement Unit

The LSM9DS1 IMU is a powerful device incorporating 9 degrees of freedom. It harnesses a 3 axis gyroscope, a 3 axis magnetometer, and a 3 axis accelerometer. It collects data for each distance recorded to develop the orientation of the scan. The IMU is powered from the 3.3V pin on the Arduino Mega and consumes 0.6 mA of current.

Micro SD Shield

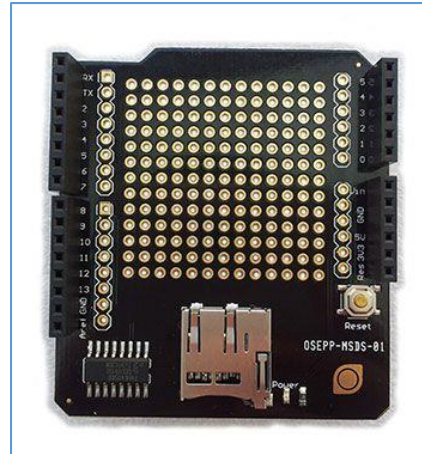

Figure 14:Micro SD Shield

The Micro SD Shield is an add on to the Arduino Mega that interfaces a micro SD card to store the collected data. After a completed scan the SD card can be removed to export the data to a computer software to generate the 3D image of the mapped cavern.

Setup

Mechanical Setup

In order to run scans with the lidar, the structure must first be constructed. Once the parts are printed using the available .stl files, construction is extremely easy. First, place the pancake stepper motor into the recessed housing on the top face of the main base. Then fasten a 5mm shaft coupler to the motor. Place the lazy susan into the recessed housing at the top of the main base. Then place the lidar base housing on top of the lazy susan and use a coupler to fast it down. Slide the motor housing into the slot on the side of the lidar housing and push a shaft through with the lidar mount in the middle. Attached a fastening coupler on the opposite side of the motor mount. Then attach the NEMA 8 stepper motor to a shaft coupler and attach the coupler to the shaft. Mount the lidar onto its base on the horizontal shaft. Finally, screw the entire assembly onto the threaded screw on the tripod and a scan is ready to be done.

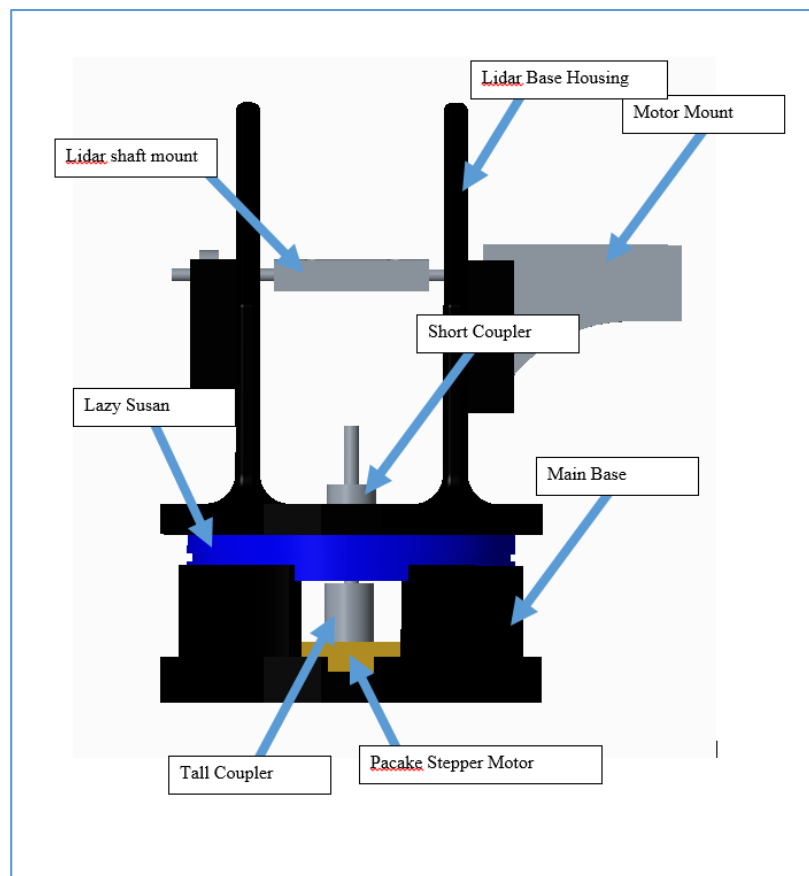

Figure 14: Assembly

Electrical Setup

After the device has been properly mounted onto the tripod, the user must verify that all electrical connections throughout the system are properly secured. This can be done by gently tracing all wires throughout the system, and ensuring that none of them have been disconnected

or unsoldered. Since the system is not currently receiving power, there is no risk of electric shock.

Next, the user must establish a link between the scanner module and the controller module by attaching their respective cables. To do so, the user must simply connect the cables coming from the scanner to the controller cables found on the outside of the storage box. During this step, the user must ensure that the cables are connected correctly. If the cables are connected incorrectly, the system will be unable to properly run a scan.

Once all required connections are in place, the cave scanner is ready to be connected to the 12V battery. The power wires for the scanner as well and the 12V battery are both located inside of the storage box. To connect the scanning system to the battery, the user must attach the positive and negative power wires to their respective battery nodes. It is very important that the positive wire is attached to the positive node, and the negative wire is attached to the negative node. Doing the opposite will short-circuit the system and damage its electrical components.

After connecting the battery to the system, the user can turn on the scanner by pressing down the power button, found on the buck converter inside of the storage box. The system is now ready to begin a cave-scanning sequence.

Deconstruction and Storage

The user can deconstruct the scanner system by performing the setup instructions in reverse order. When taking apart the scanner, the user must make sure not to accidentally disconnect any wires from their respective nodes. All components besides the tripod can be stored inside of the storage box. The user must make sure to position all the equipment in a manner that doesn't damage any part of the design. The user must also ensure that the battery is properly secured and not exposed to any electrical wire or other conducting material.

Libraries

In order for the device to properly operate, the user must install three separate libraries onto the Arduino IDE software used to code the microcontroller. The required libraries can be installed using the following links:

- LiDAR lite V3: https://github.com/garmin/LIDARLite_v3_Arduino_Library
- IMU: https://github.com/sparkfun/SparkFun_LSM9DS1_Arduino_Library
- SD card mount: <https://github.com/adafruit/SD>

Operation

WARNING: DO NOT STARE DIRECTLY AT THE LIDAR LASER

The LiDAR cave mapper device should run autonomously. Once the device is setup and initialized using the start button, the user can leave it running. It will wait for a few minutes for the user to leave, then run an initial scan. After the basic scan the LiDAR will pick an operation mode, then scan the surrounding cave in methodical steps.

It may take 2 hours or more for the LiDAR device to run a complete scan. When the user returns, there should be a solid LED lit on the device indicating the finished status. If the light is blinking, then the scan is still running. The user should be cautious not to look directly at the laser when a scan is running. They should avoid the laser's path completely, if possible, as they will interfere with the scan.

Once the scan is complete the user can turn off the power switch. They should remove the micro SD card from the shield on the Arduino. This is located inside the casing. Then the user can complete storage of the device as specified in the setup/storage section.

Once the user has a computer available, they can use an SD card adapter to connect the micro SD card. The user should then plug in the SD card, and open the data file in a point cloud viewing software such as PTC Creo, MeshLab, or Point Cloud Library.

Troubleshooting

Wiring and Signal Problems

If no signal is received, check for loose connections. All wires should be connected as shown in the appendix. Inspect the wires for any discrepancies like exposed wire or dull looking solder. Wires may need to be replaced or re-soldered to fix worn connections.

If all connections appear secure, make sure the power is on. There should be LED indicators lit on the Arduino, shield, and motor controller. The batteries must be plugged in and the switch to the buck converter on. If power is on and no indicators are lit, recheck connections.

Slipping

If the LiDAR is slipping on the shaft that runs through it, readjust the grommets to make sure they are holding tight to the LiDAR base.

If the motor is rotating but the shaft is not, check the couplers on both sides of the mount to make sure all tap screws are tight against the shaft using an Allen key.

Sticking

If the lazy Susan bearing is not rotating smoothly under the base, sprinkle some powdered graphite in the groove to provide lubricant on the bearings.

Uploads

If you're reuploading, install all the necessary libraries first! Make sure the baud rates match. An Uno should use 9600 bps. A Mega can do 38400 bps or more.

Changing Hardware

SD cards need to be formatted as FAT16 or FAT32. The hardware pins change with different shields, so research may be required. For the OSEPP SD shield used here, pin 8 works on the Uno, and pins 10-13 are needed for the Mega. The IMU also changes from pins A4 & A5 on the Uno, to the defined SDA and SCL pins 20 and 21 on the Mega. The IMU must use these two SPI pins or it will not work! Motors can be moved to PWM pins for an Uno.

Appendix

Electronics	Rated Voltage (V)	Supplied Voltage (V)	Rated Current (mA)	Supplied Current (mA)
Lidar Lite V3	5	5	135	135
Inertial Measurement Unit	3.3	3.3	0.6	0.6
NEMA 8 Stepper Motor	4	2	600	From EZ Driver
NEMA 8 EZ Driver	9	9	200	200
Pancake Stepper Motor	4.5	2.2	1000	From EZ Driver
Pancake EZ Driver	9	9	300	300
Arduino Mega	9	9	200	200

Power Sonic PS-1270	
Nominal Voltage	12 V
Nominal Capacity	7 AH
Weight	4.8 lbs (2.18 kg)
Length	5.95 in (151 mm)
Width	2.56 in (65 mm)
Height	3.86 in (98 mm)
Energy Density	1.49 Wh/in ³ (90.95 Wh/l)
Specific Energy	17.5 Wh/lb (38.58 Wh/kg)
Internal Resistance	23 mΩ

Operating Temperature	Charge: -4°F to 122°F (-20°C to 50°C)
	Discharge: -40°F to 140°F (-40°C to 60°C)

Shelf Life	1 Month.....97%
	3 Months.....91%
	6 Months.....83%

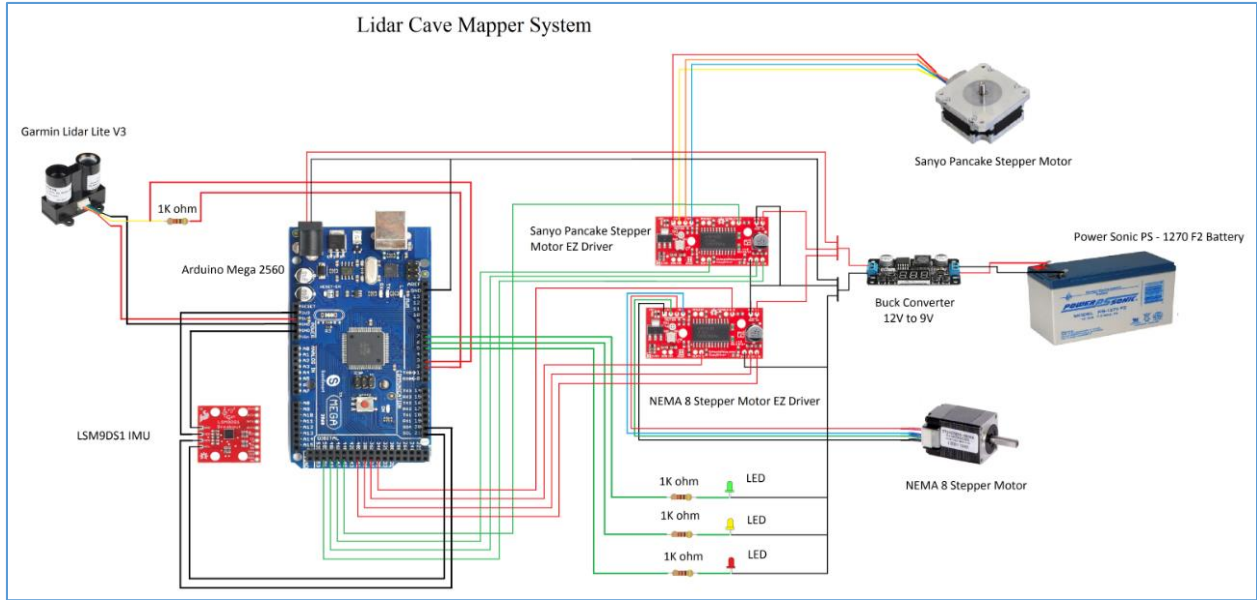

Figure A 1: Total wiring schematic

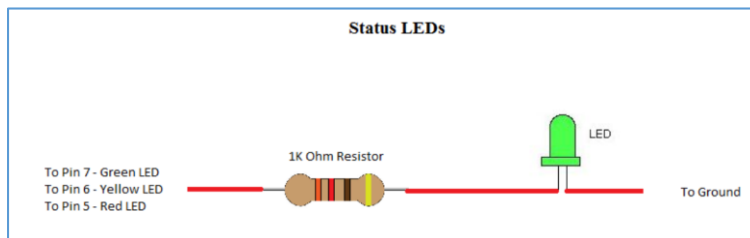

Figure A 2: Status LED wiring

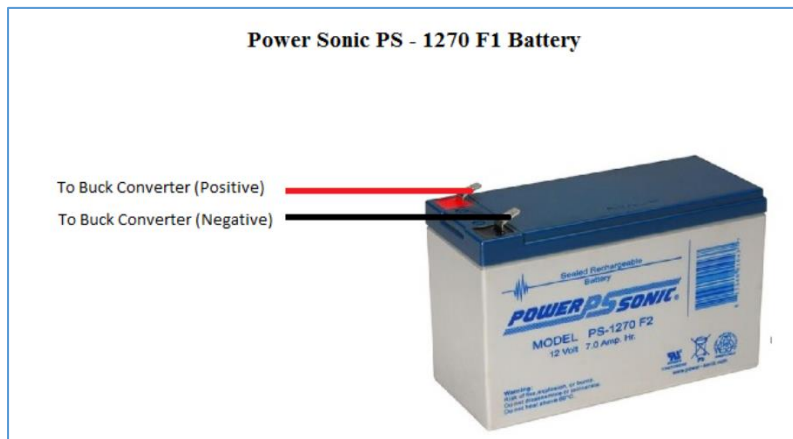

Figure A 3: Battery wiring

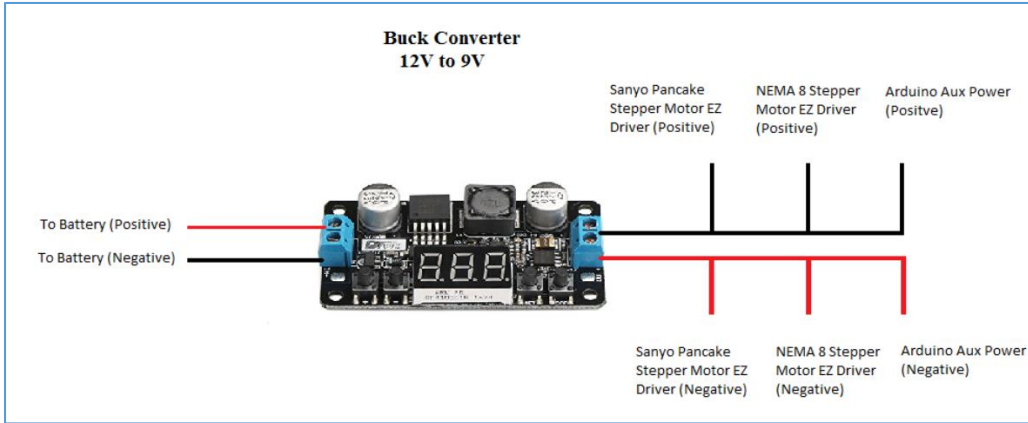

Figure A 4: Buck Converter wiring



Figure A 5: NEMA 8 wiring

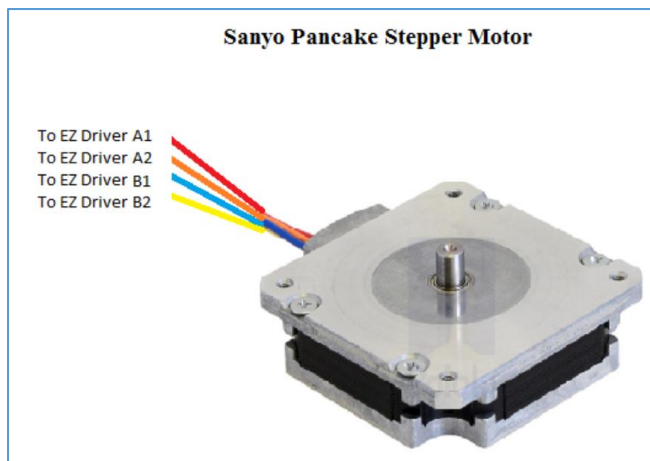

Figure A 6: Sanyo Pancake wiring

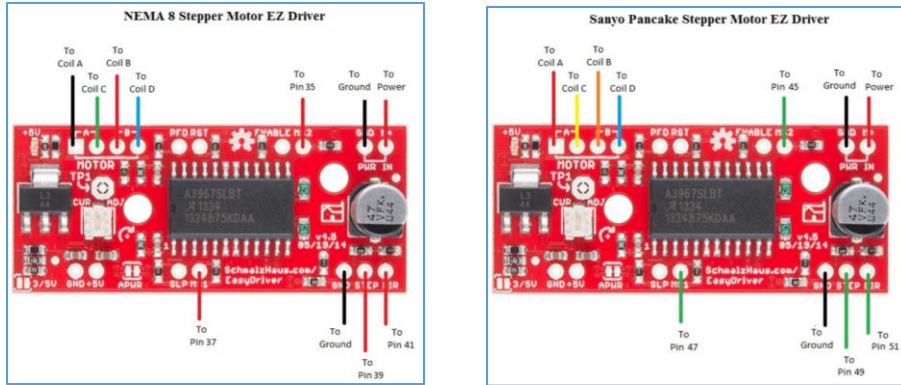

Figure A 7: Stepper Motor EZ Driver wiring

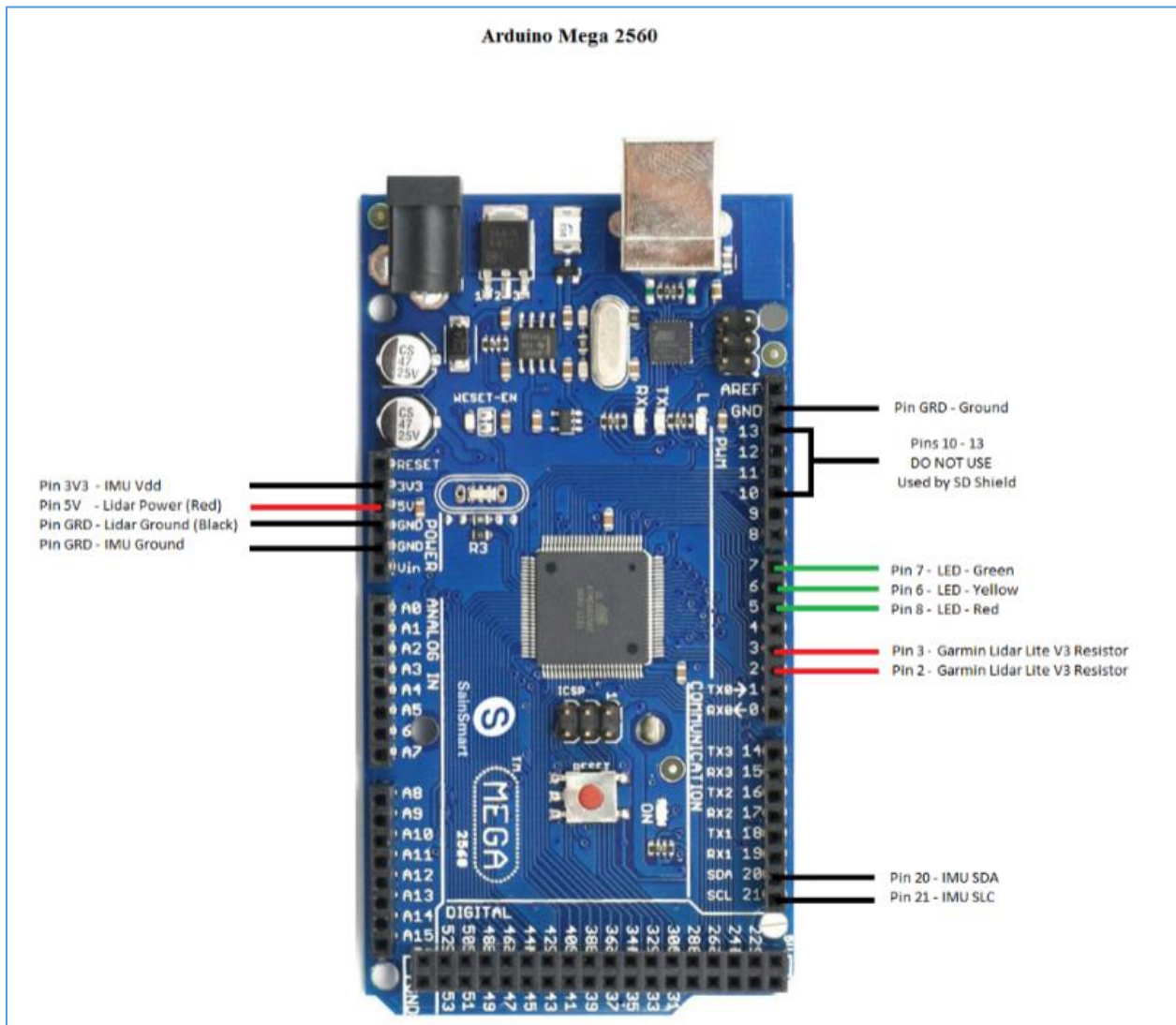

Figure A 8: Arduino Mega Connections

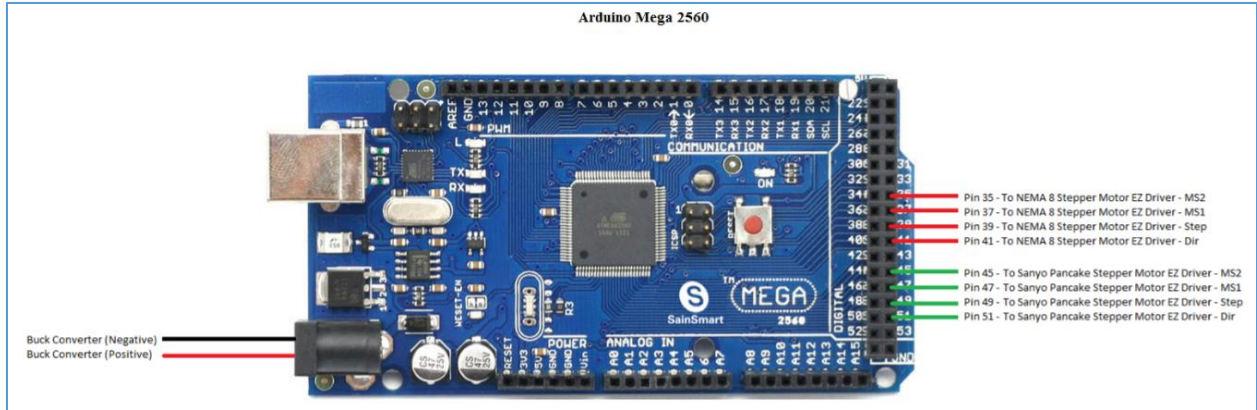

Figure A 9: Additional Arduino Mega Connections



Figure A 10: LiDAR Lite V3 wiring

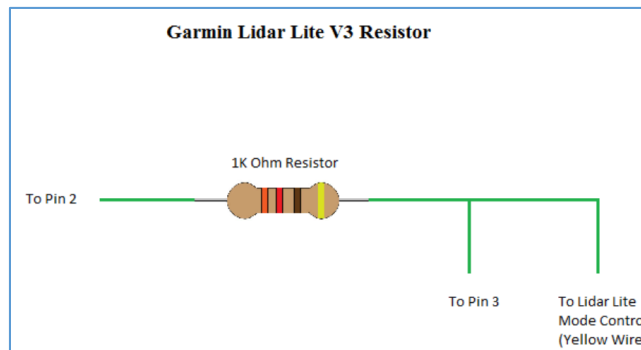

Figure A 11: LiDAR Lite V3 wiring + resistor

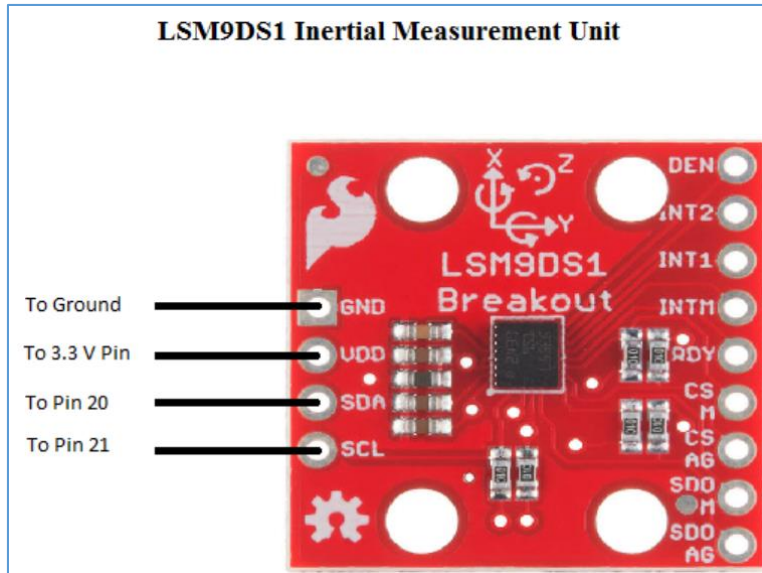

Figure A 12: IMU Connections



Figure A 13: SD shield covering mega pins (extend)

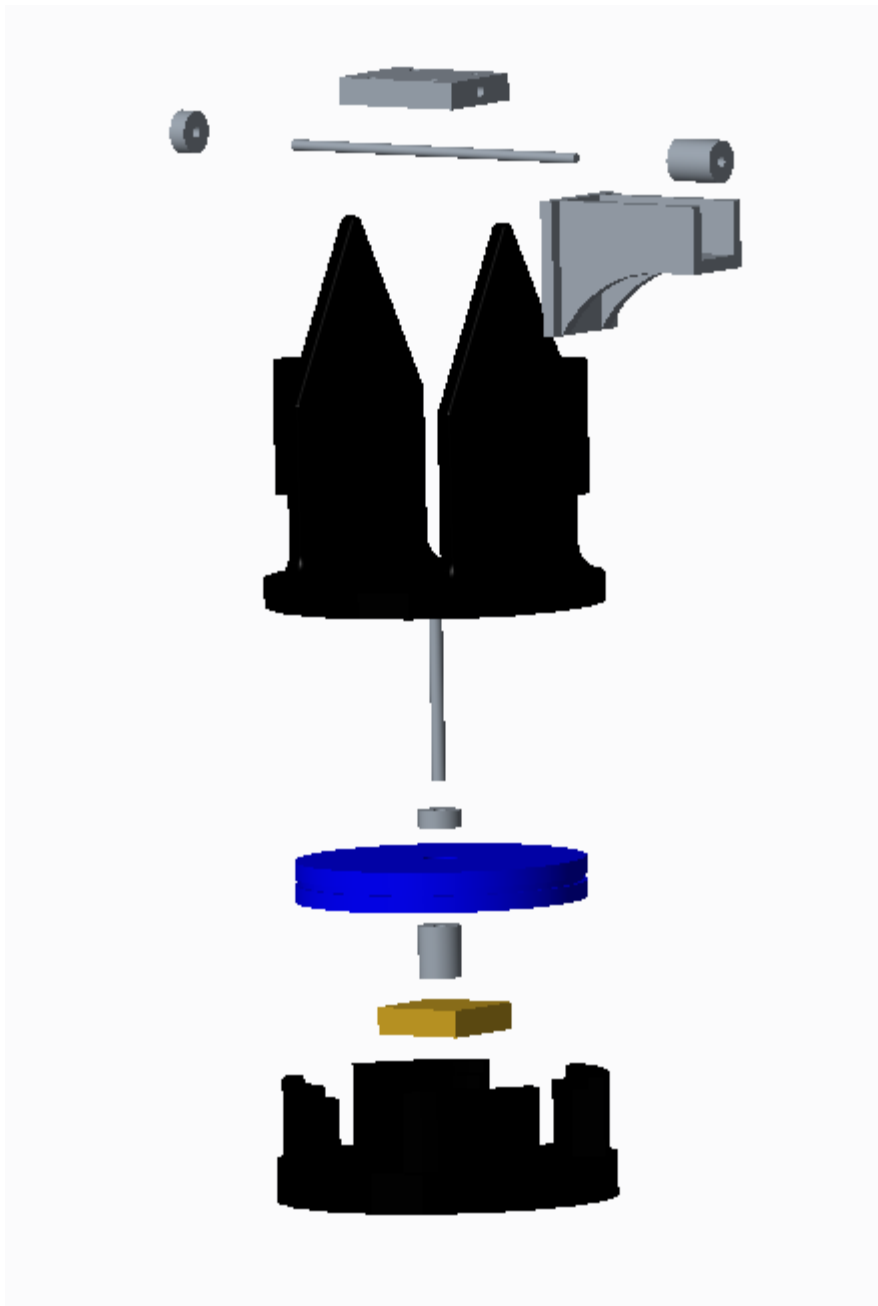

Figure A 14: 3D blowup of scanning fixture