

MICROGRAVITY MACHINE

Design Review 5



TEAM 511



Samuel Duval

Propulsion Engineer



Pedro Siman

Recovery Engineer



Thomas Lenz

*Test & Systems
Engineer*



Collin Gainer

*Aero Design
Engineer*



John
Tietsworth

Controls Engineer

Thomas Lenz

Sponsor and Advisor



Dr. Mohd
Yousuf Ali

**FAMU-FSU
College of
Engineering**



Mike Conroy

**Florida Space
Grant
Consortium**



Dr. Shayne
McConomy

**FAMU-FSU
College of
Engineering**

Thomas Lenz

Project Objective

The objective of the project is to design a reproducible system that can be dropped, achieve microgravity during its descent, and be safely recovered for reuse.

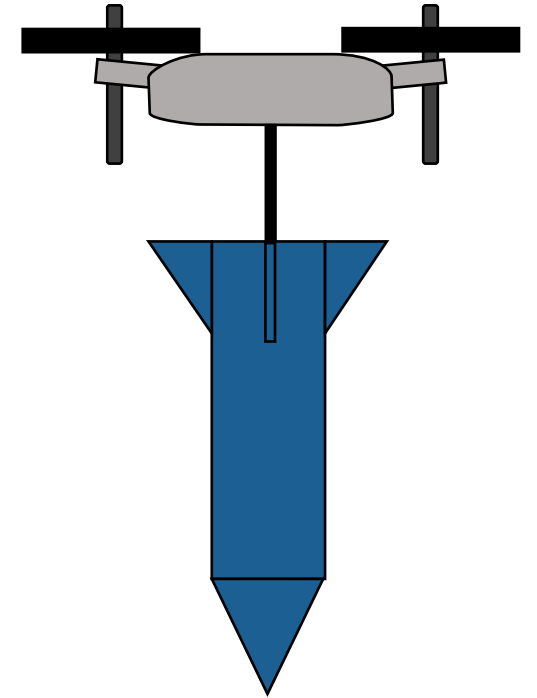

Thomas Lenz

What is Microgravity?

$$\vec{F}_{Specific} = \frac{\sum \vec{F}_{nongravitational}}{m} \approx 0 \frac{m}{s^2}$$

What does an
accelerometer measure?

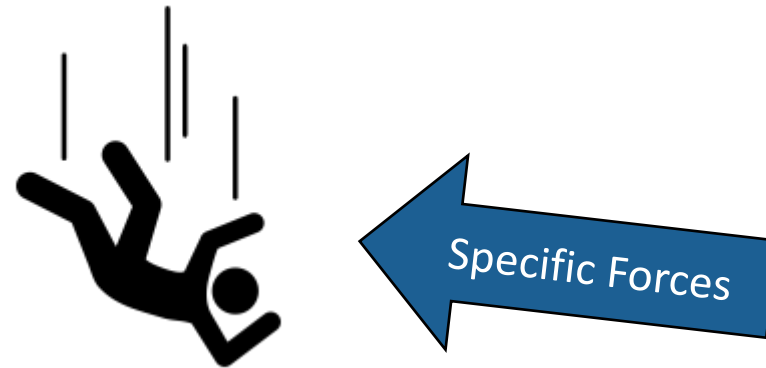

Thomas Lenz

Achieving Freefall

$$\vec{F}_{Specific} = \frac{\vec{F}_{Propulsive} - \vec{F}_{Drag}}{m} \approx 0 \frac{m}{s^2}$$

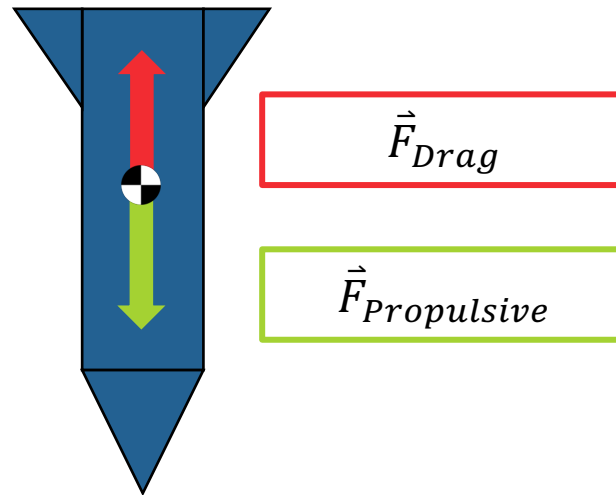

Thomas Lenz

Key Goals



Microgravity



Recoverable

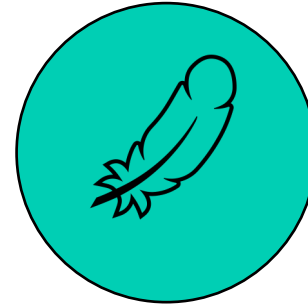

Meet weight requirements

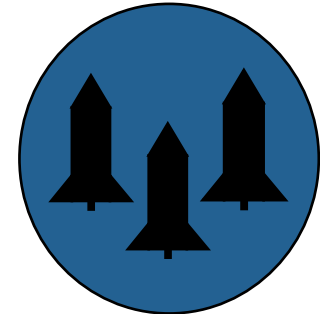

Reproduceable

Thomas Lenz

Competition Day

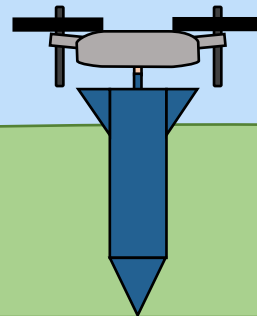

Thomas Lenz

Competition Day

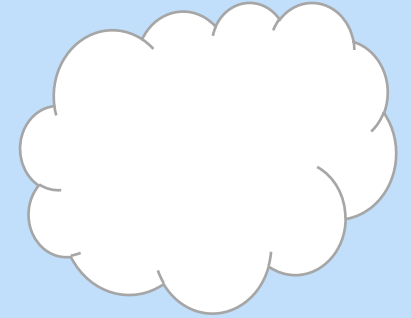
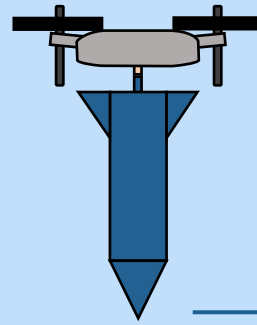

900 ft (275m)



$$\vec{a} = 9.81 \frac{m}{s^2}$$

Metric	Target
Time to Detect Disconnection	0.1s
Degrees of Freedom	1
Acceleration	$9.81 \frac{m}{s^2}$
Final Velocity	$5 \frac{m}{s}$

Thomas Lenz

Competition Day

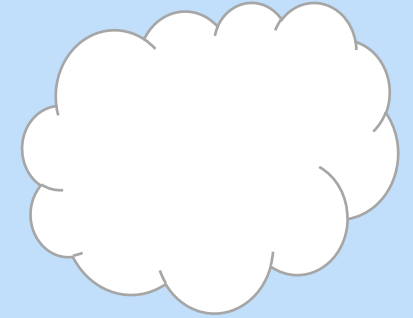
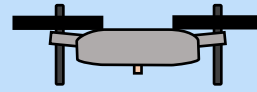

Metric	Target
Time to Detect Disconnection	0.1s
Degrees of Freedom	1
Acceleration	$9.81 \frac{m}{s^2}$
Final Velocity	$5 \frac{m}{s}$

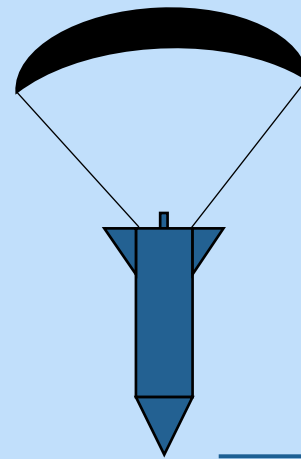

~650 ft (200m)

Thomas Lenz

Competition Day

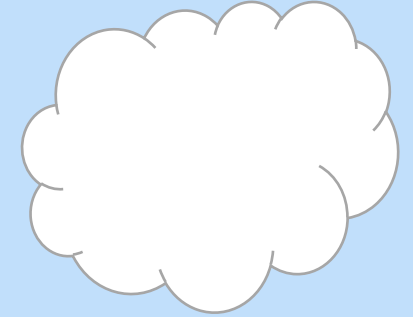
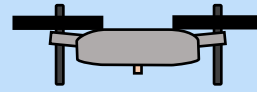

Metric	Target
Time to Detect Disconnection	0.1s
Degrees of Freedom	1
Acceleration	$9.81 \frac{m}{s^2}$
Final Velocity	$5 \frac{m}{s}$

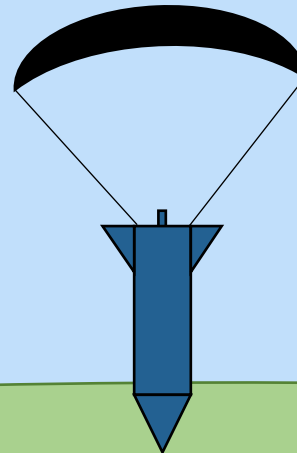

$$\vec{V}_f = 5 \frac{m}{s}$$

Thomas Lenz



Concept Generation



Propulsion	Recovery	Body	Stabilize
Expel propellant from nose of vehicle	Rear deployed parachute	Pointed front, blunt back	Fins
Expel propellant from sides of vehicle	Airbrakes	Football shape	Use water to spin the body
Electric motor propeller at the rear of the device	Airbag	Rubbery Skin	Use airbrakes to make it spin
Electric motor propeller at the front of the device	Side deployed parachute	Needle like, long and skinny	Thrust vectoring
No propulsion			

Thomas Lenz

Design #1: Nose Fluid Propulsion

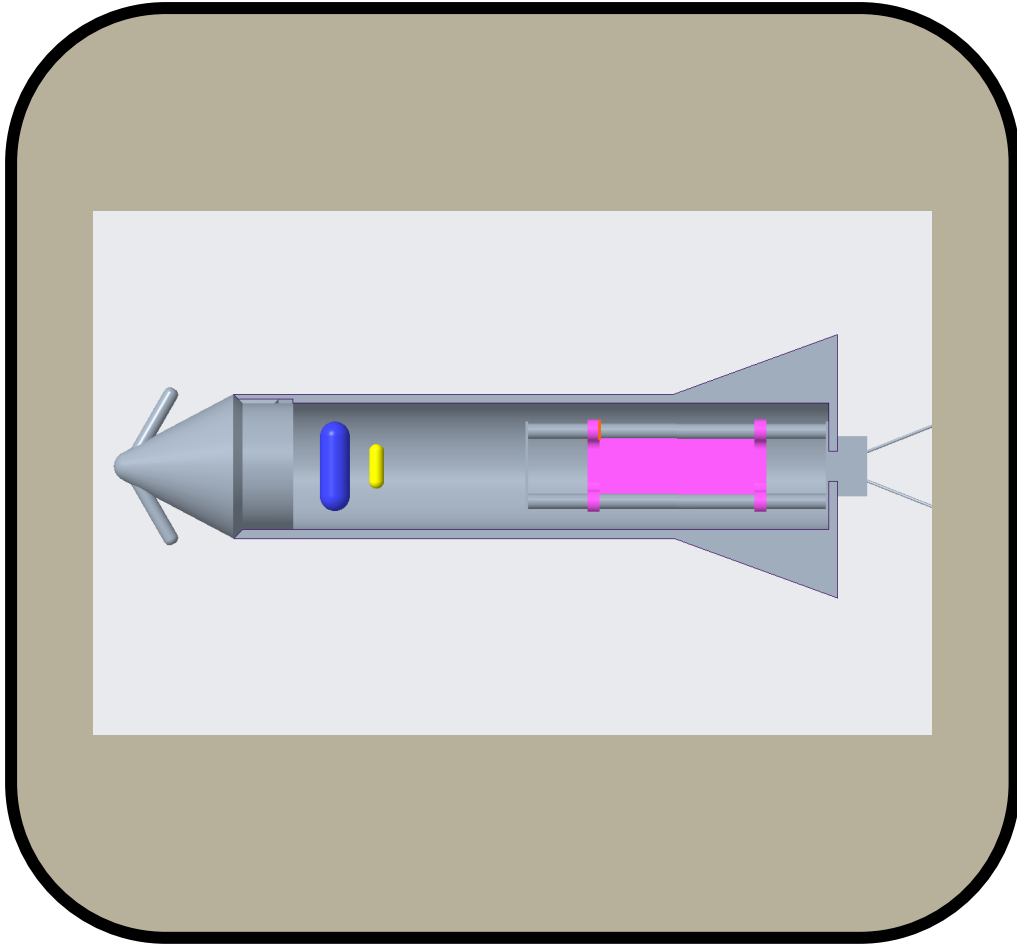

Thomas Lenz

Design #1: Nose Fluid Propulsion

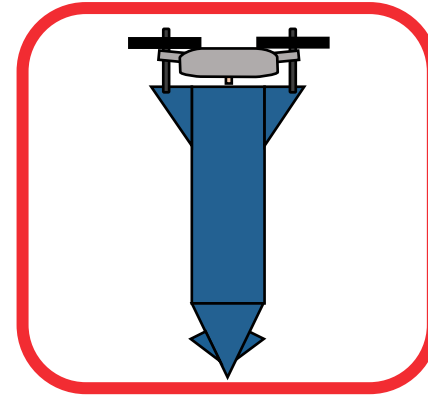
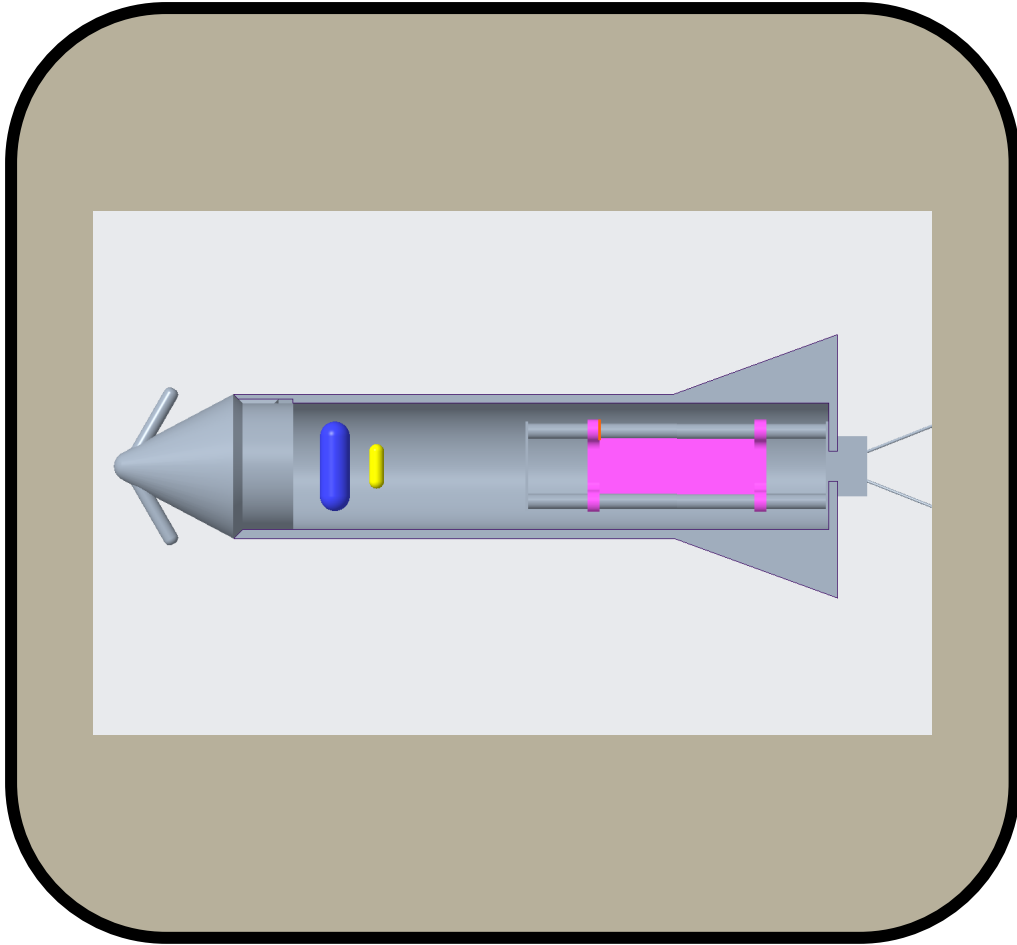

Thomas Lenz

Design #1: Nose Fluid Propulsion

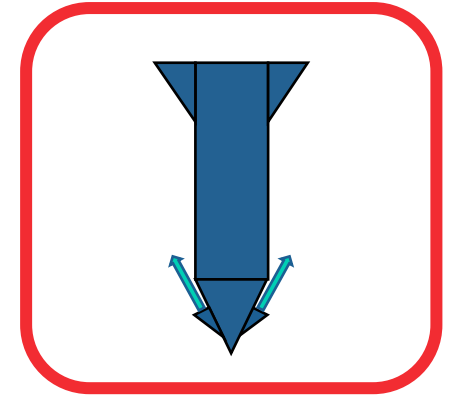
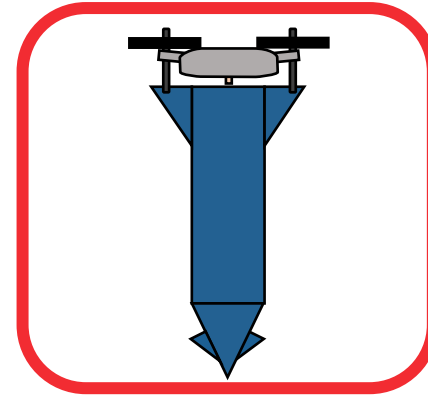
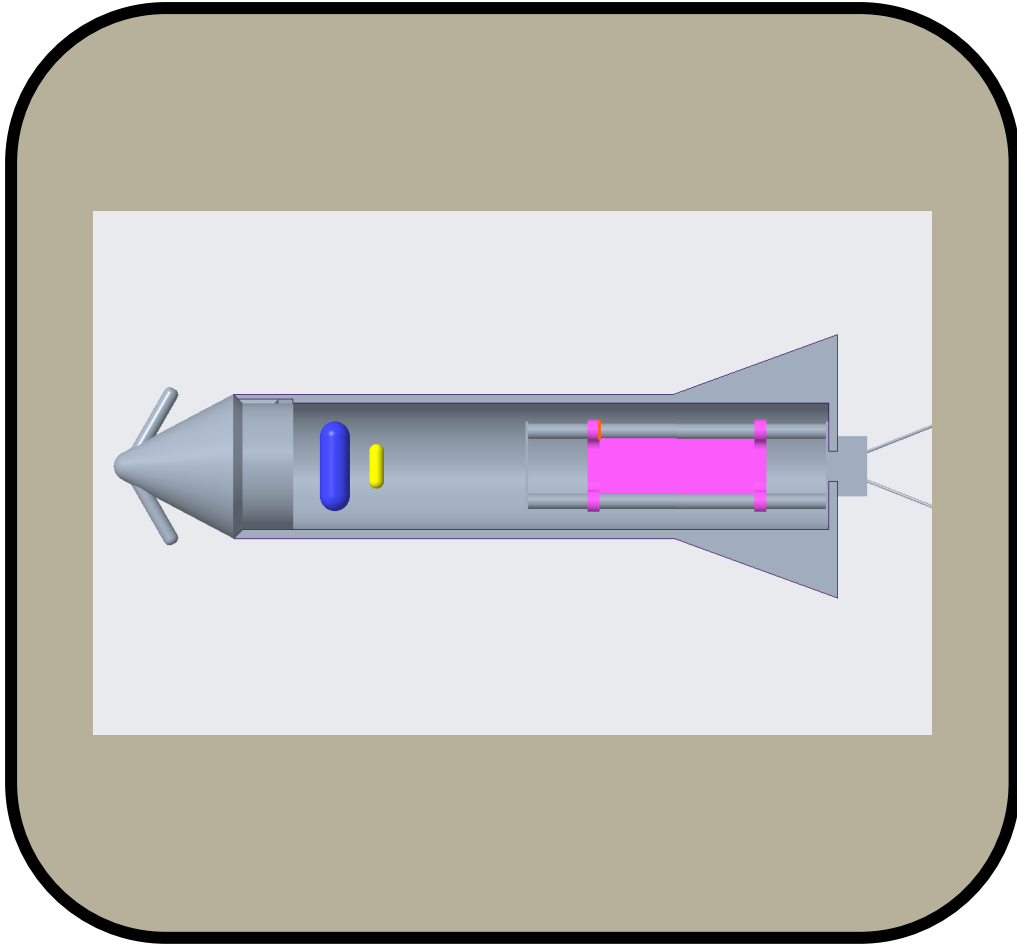

Thomas Lenz

Design #1: Nose Fluid Propulsion

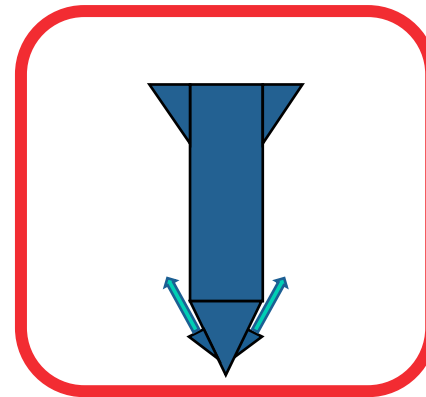
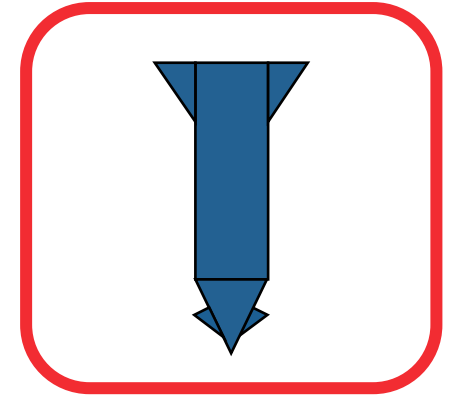
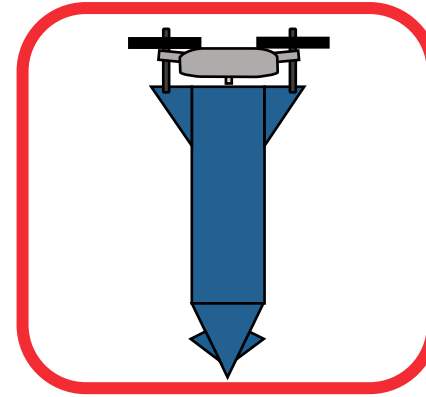
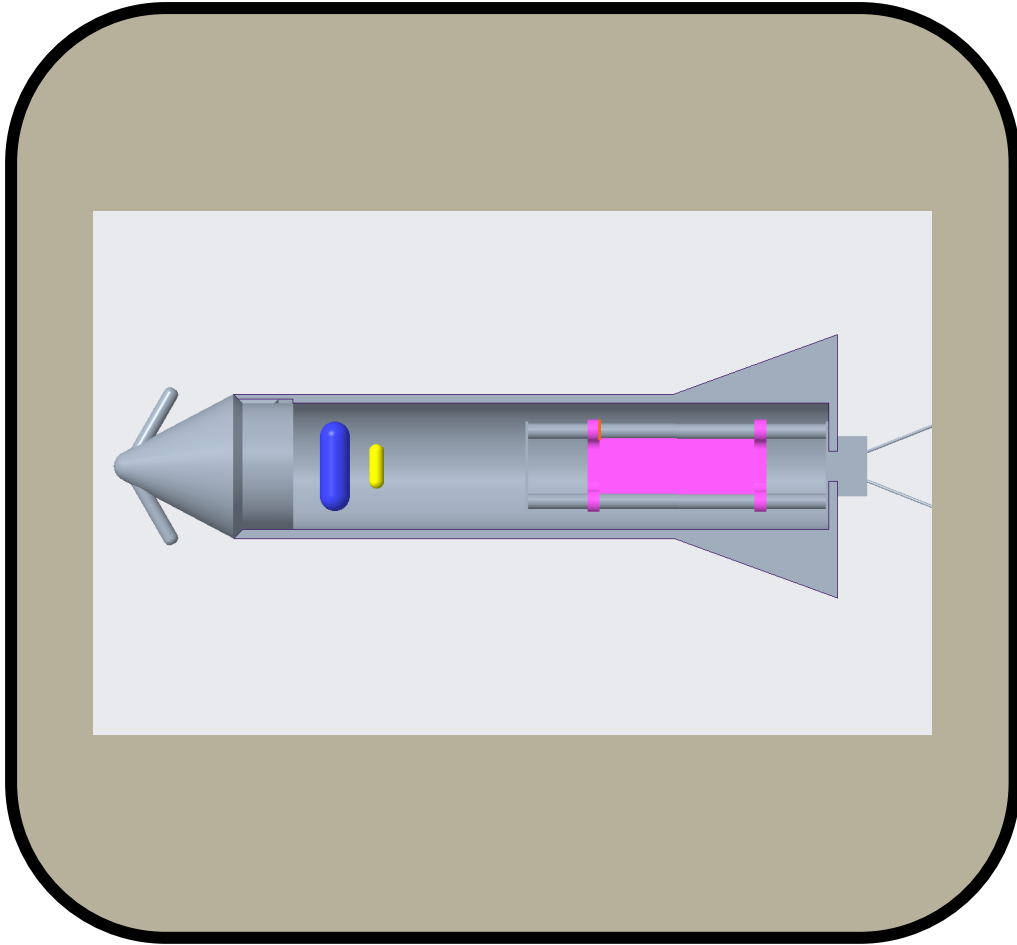

Thomas Lenz

Design #1: Nose Fluid Propulsion

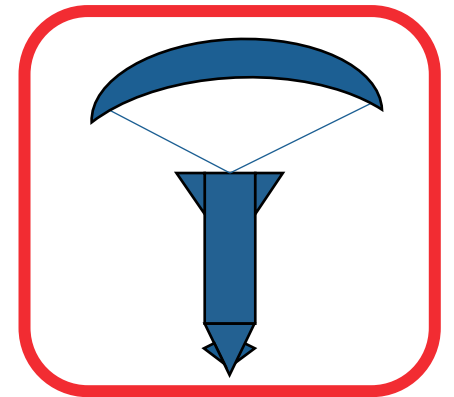
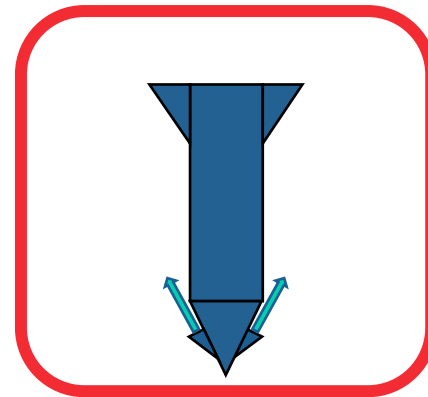
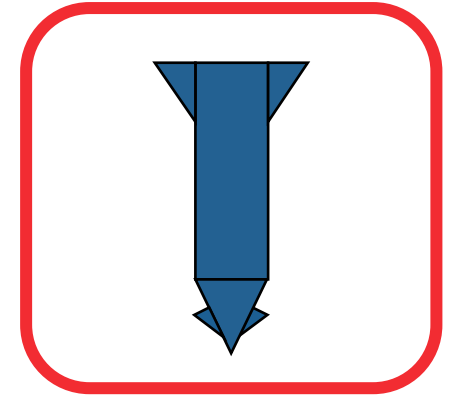
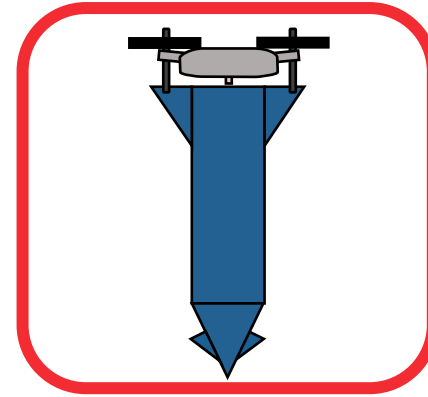
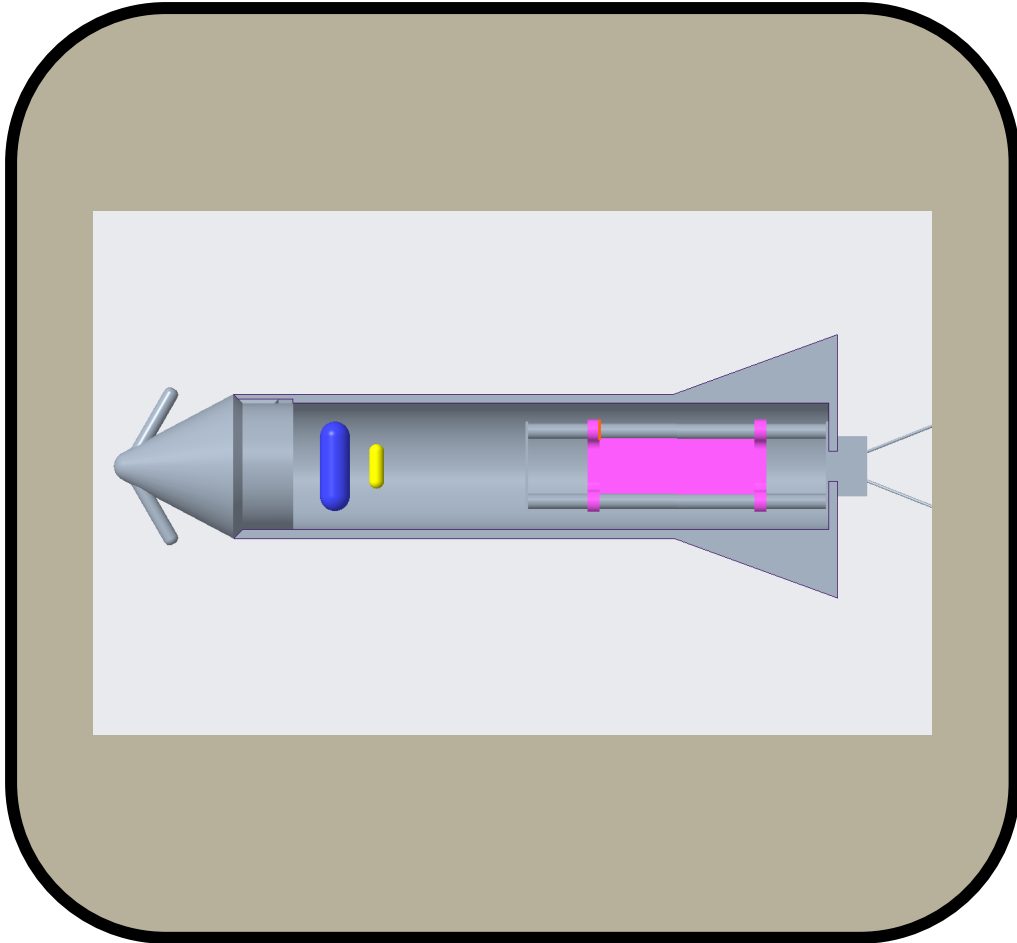

Thomas Lenz

Design #2: Parachute at Nose

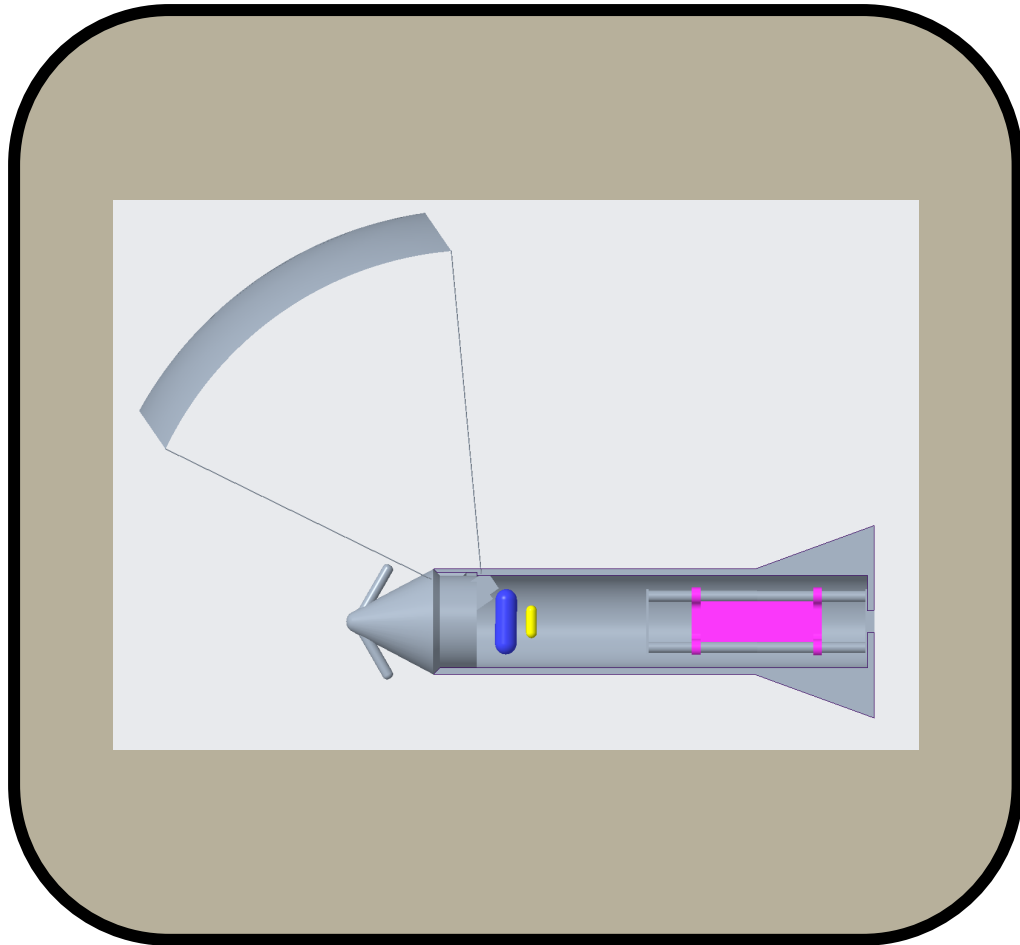

Thomas Lenz

Design #2: Parachute at Nose

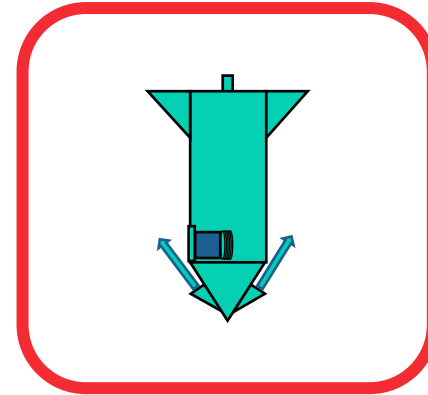
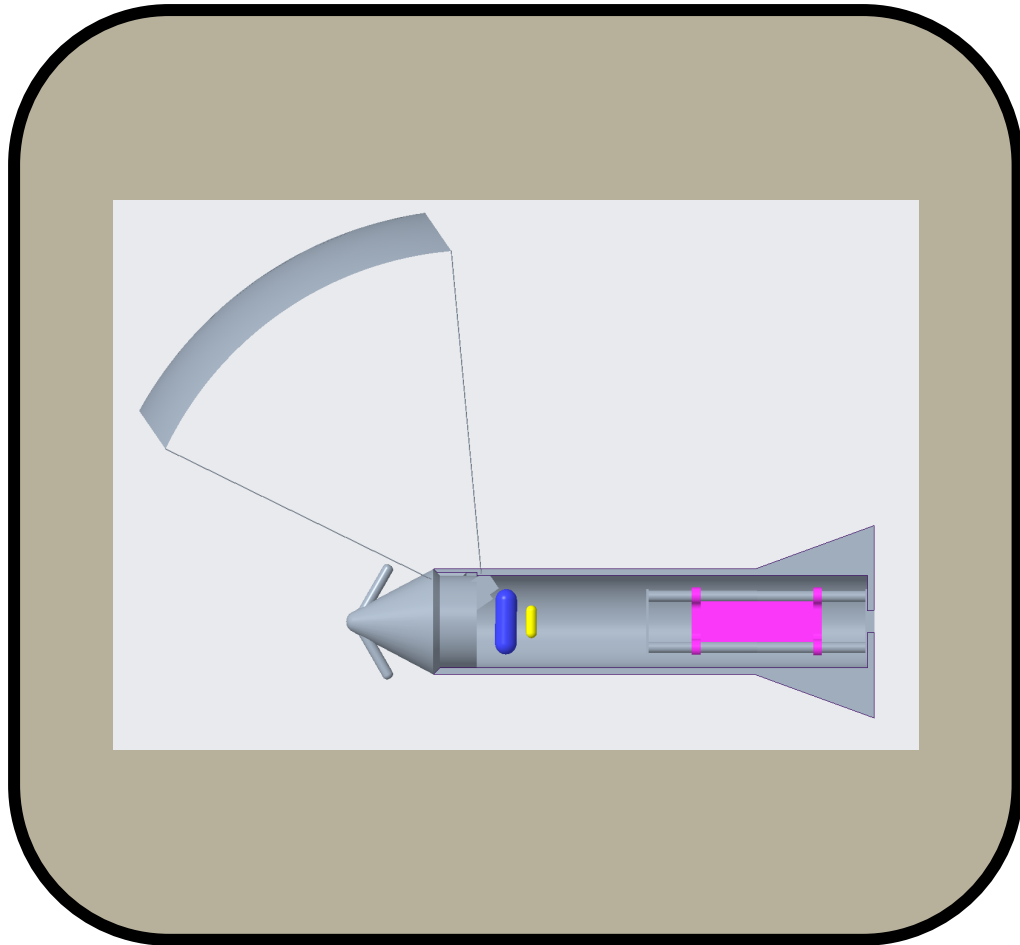

Thomas Lenz

Design #2: Parachute at Nose

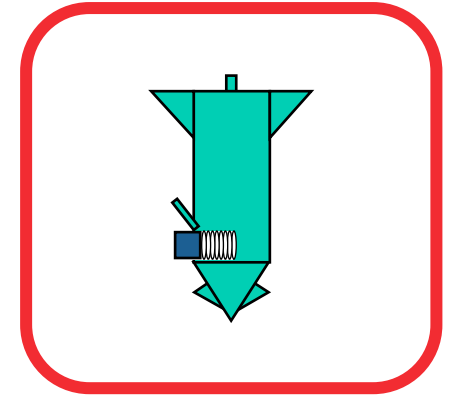
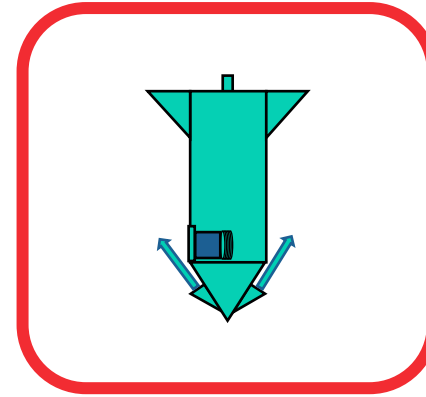
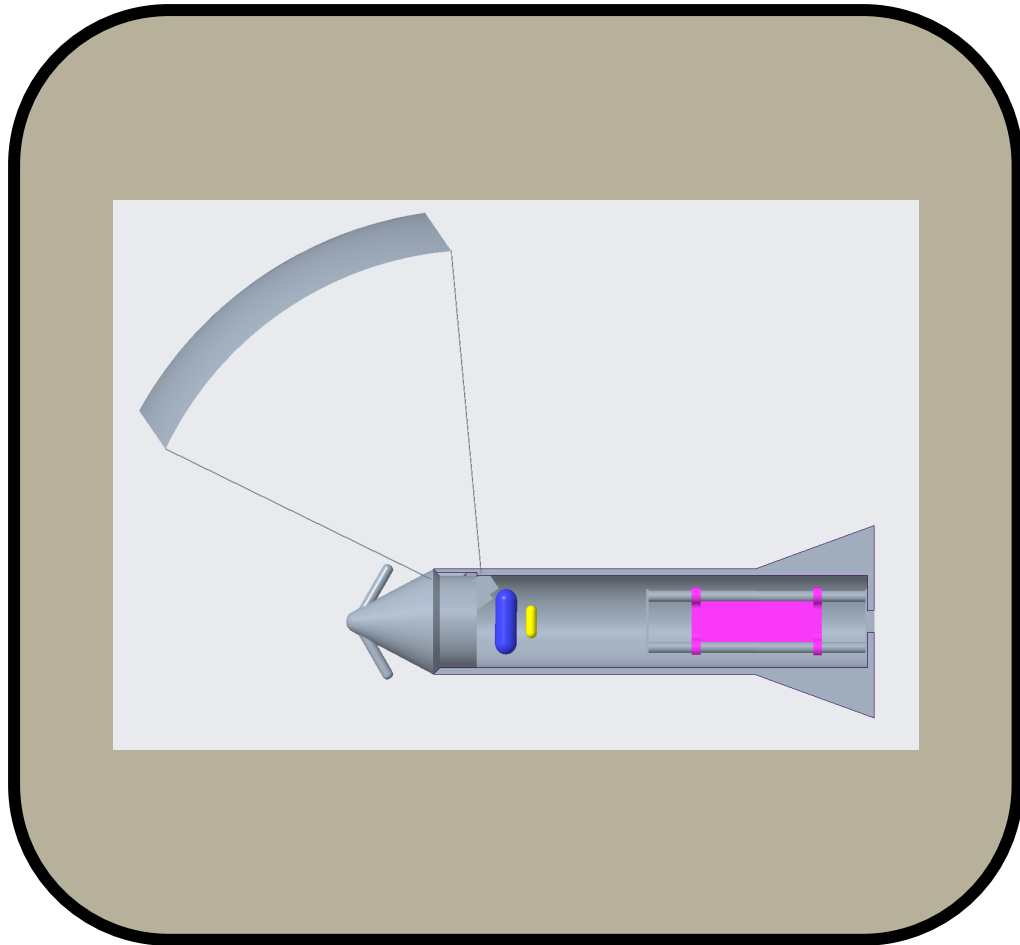

Thomas Lenz

Design #2: Parachute at Nose

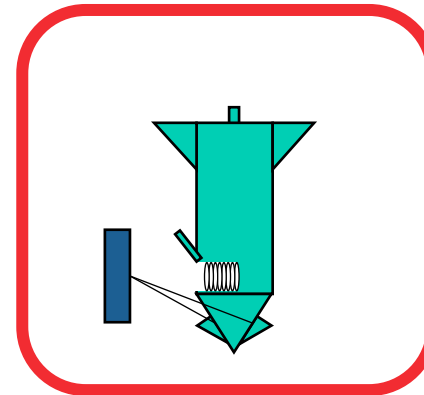
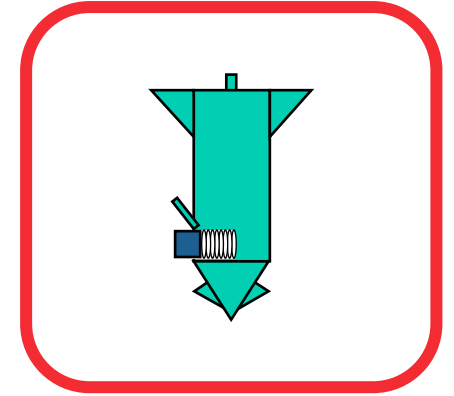
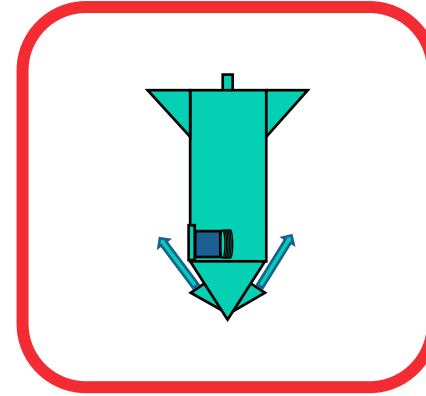
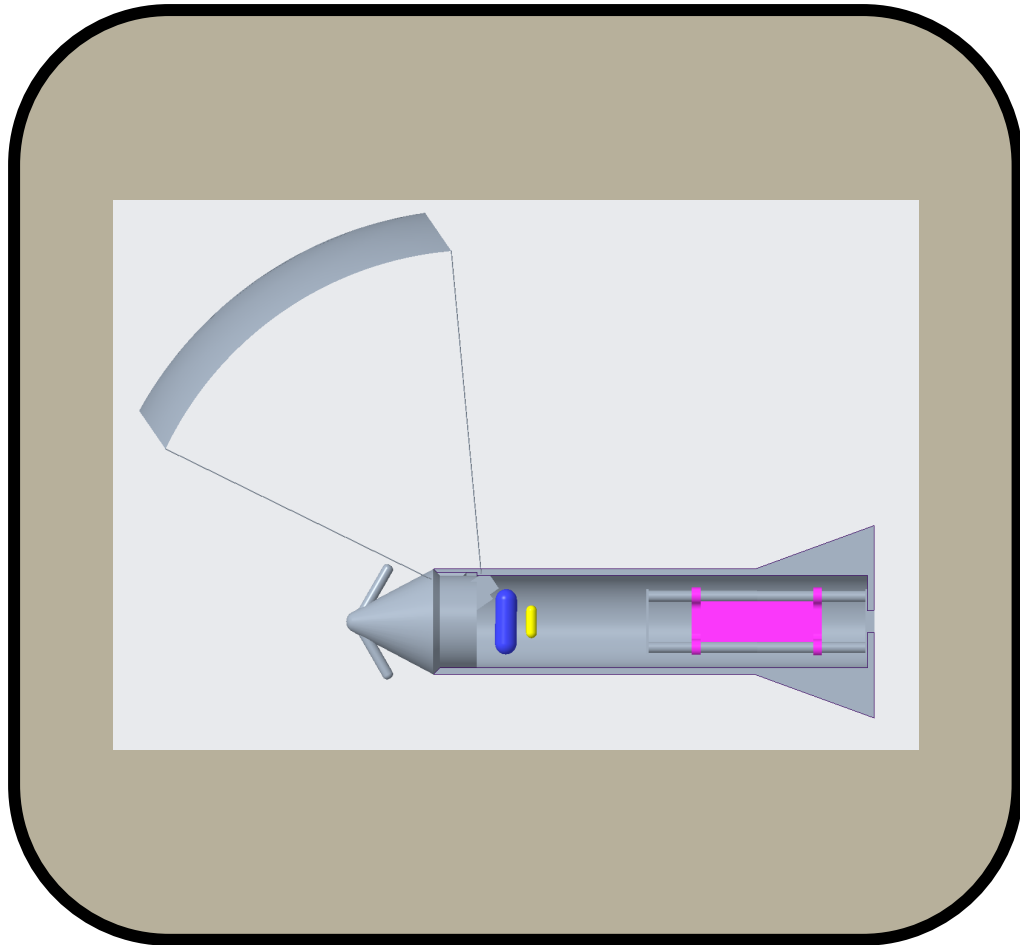

Thomas Lenz

Design #2: Parachute at Nose

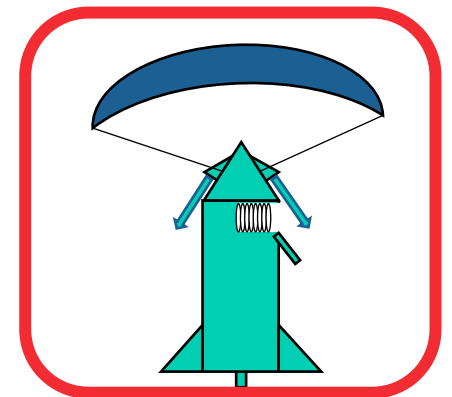
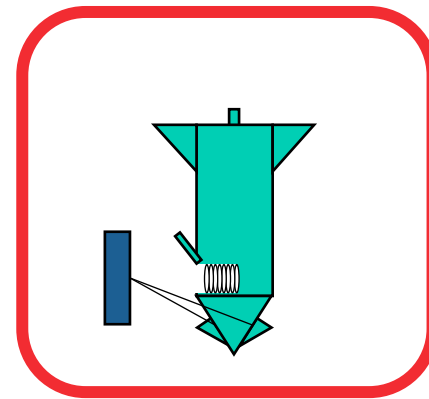
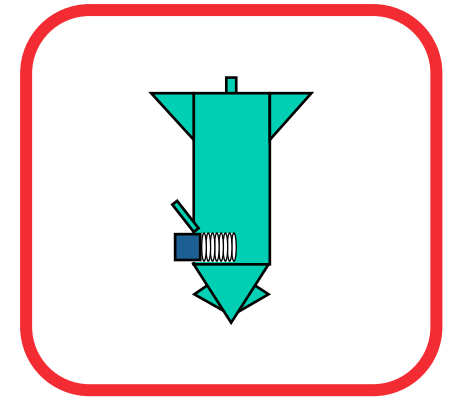
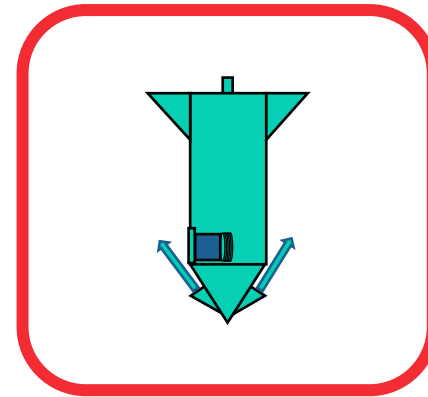
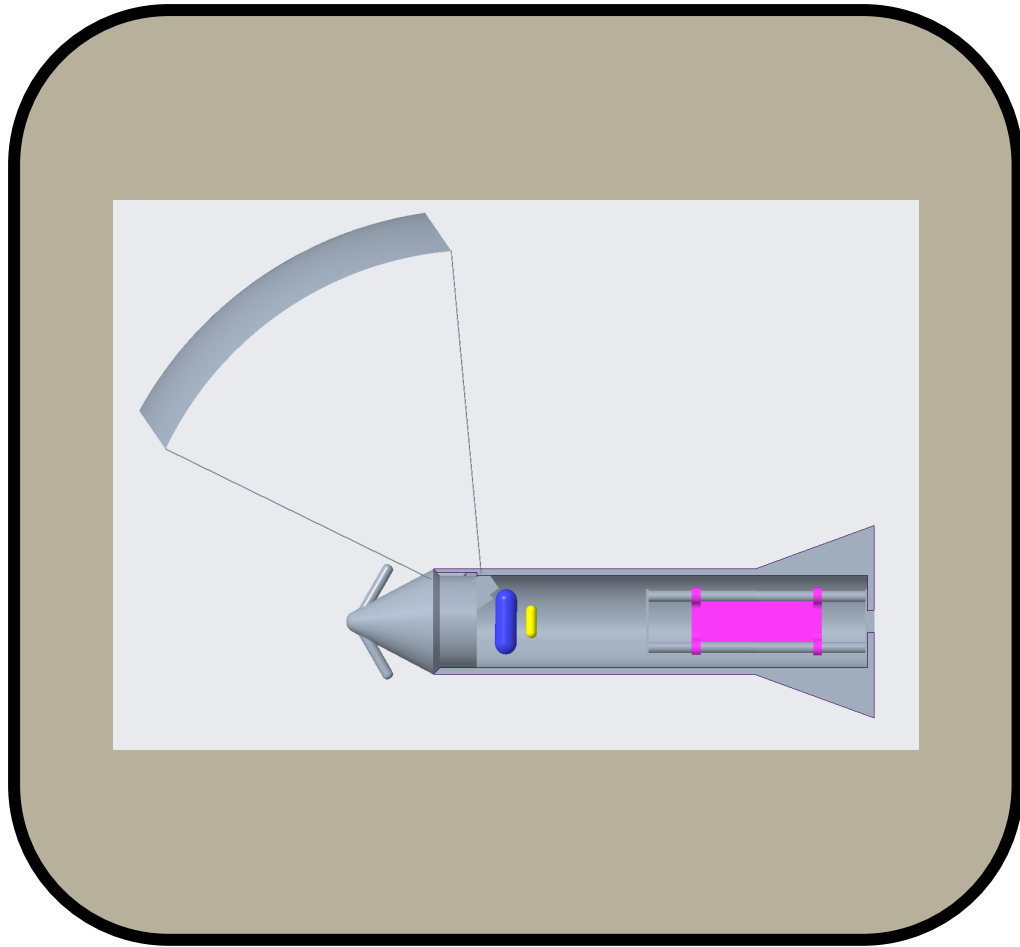

Thomas Lenz

Selected Design: Ducted Fan

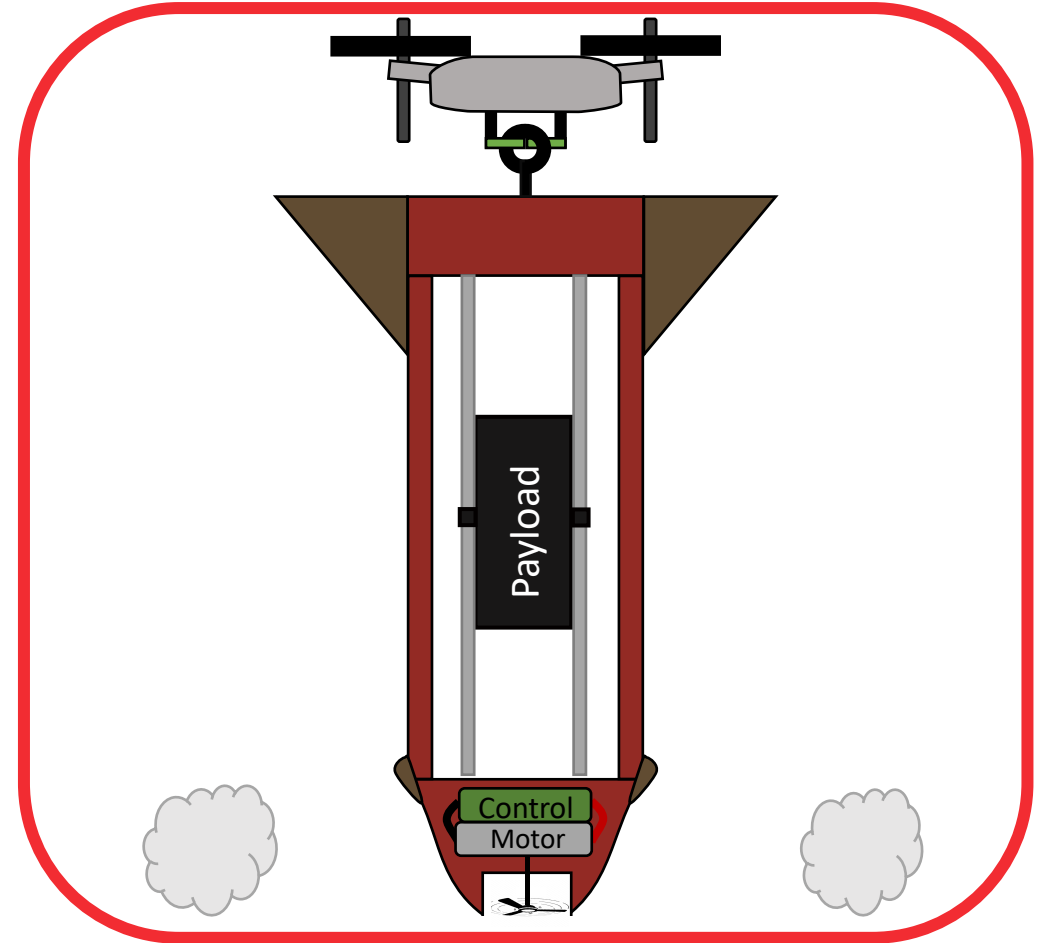

Collin Gainer

Selected Design: Ducted Fan

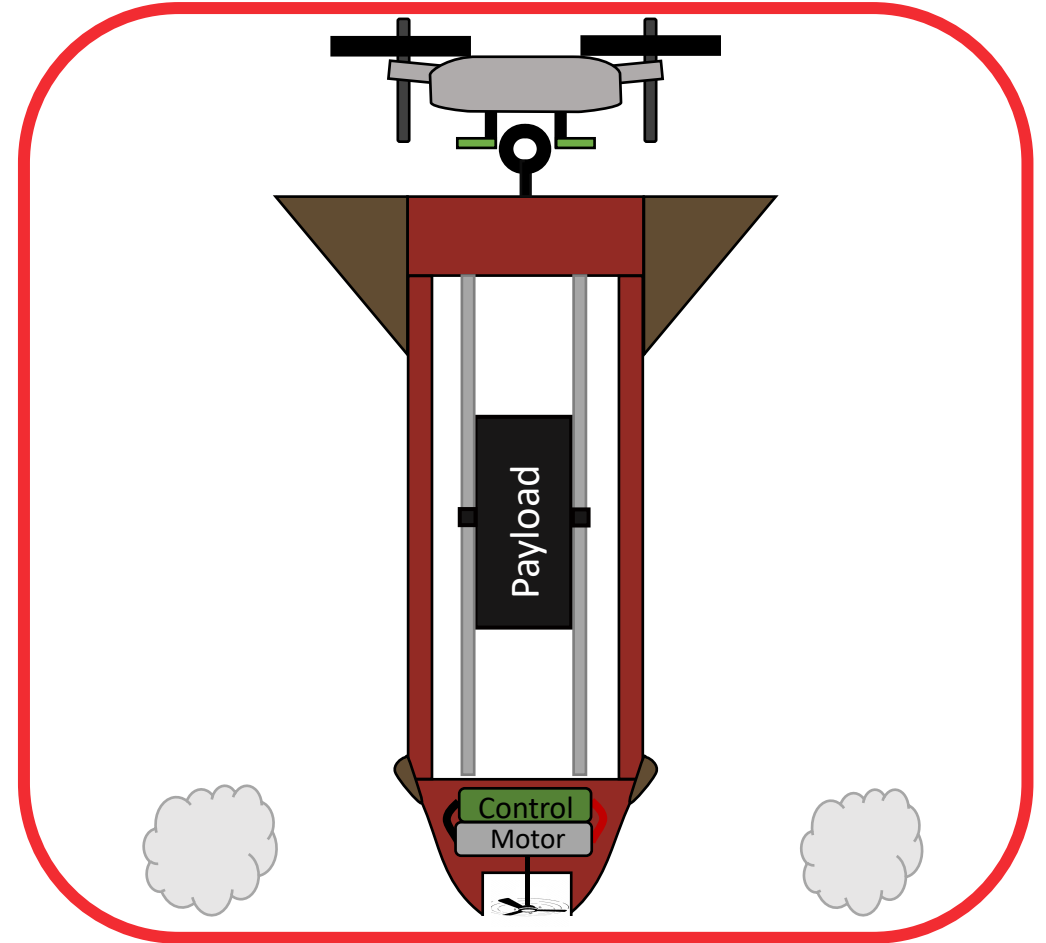

Collin Gainer

Selected Design: Ducted Fan

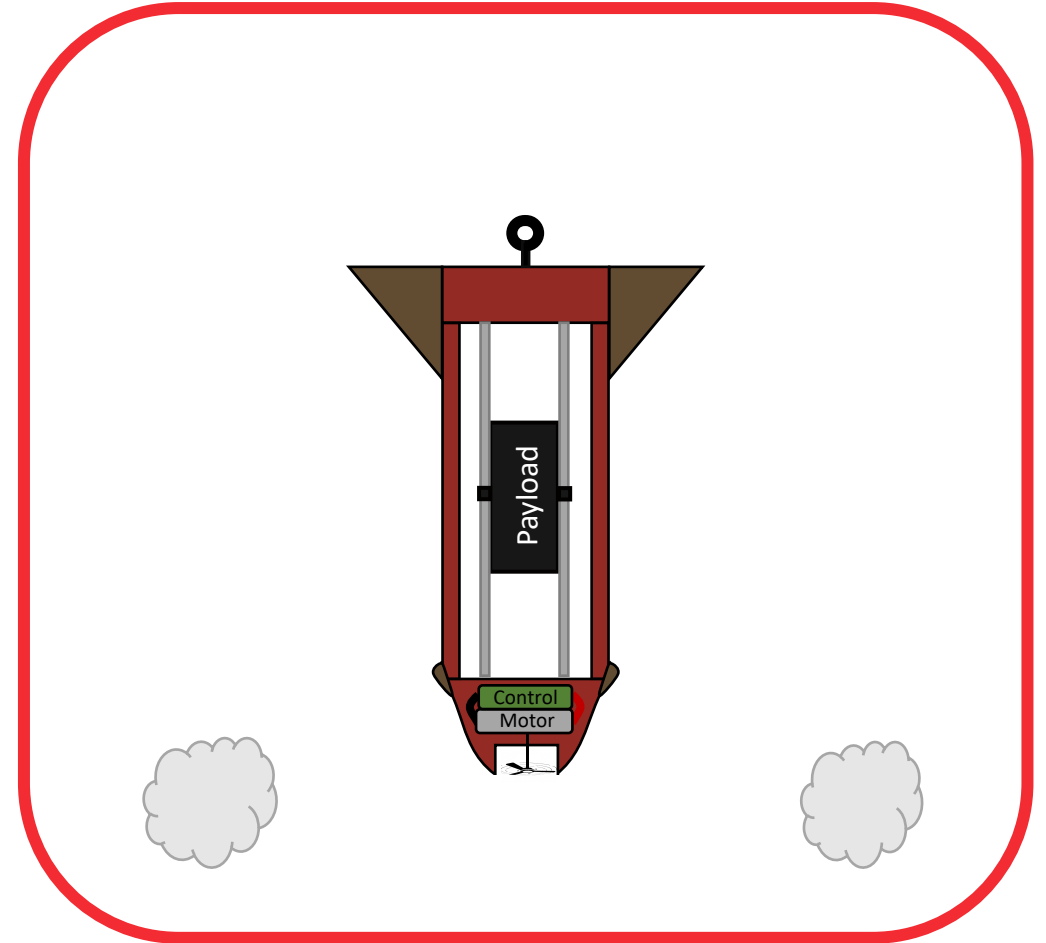

Collin Gainer

Selected Design: Ducted Fan



Drag forces act on the body
as velocity increases

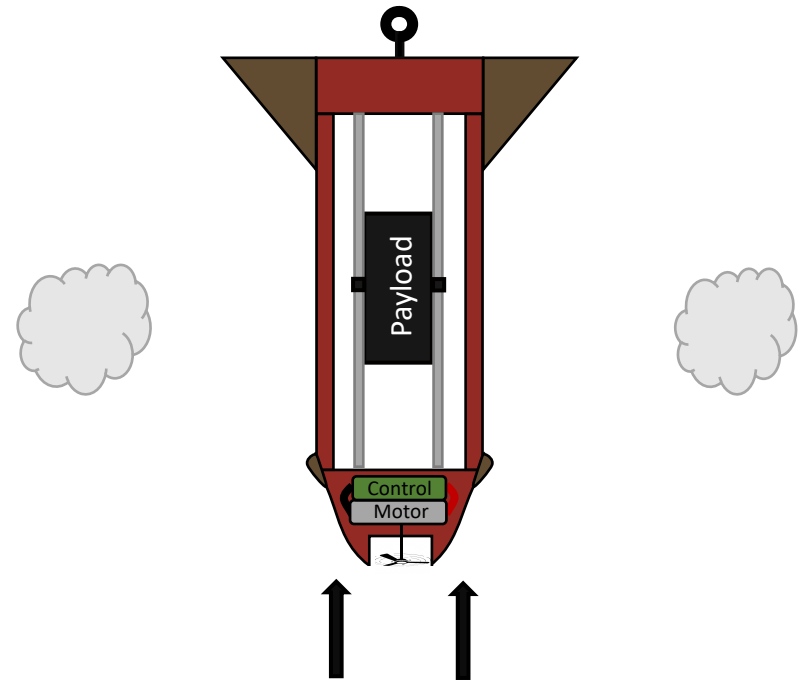

Collin Gainer

Selected Design: Ducted Fan



Payload slides along rails in the body

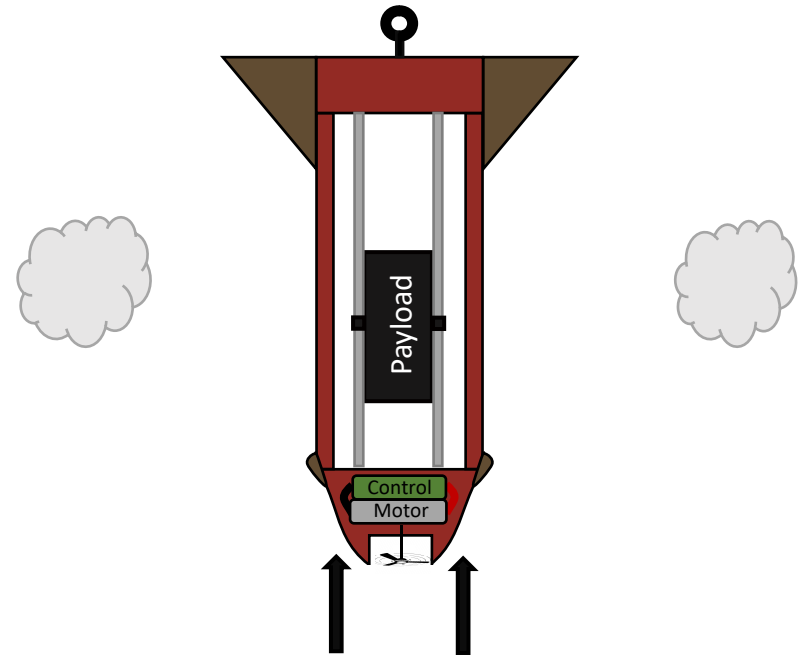

Collin Gainer

Selected Design: Ducted Fan

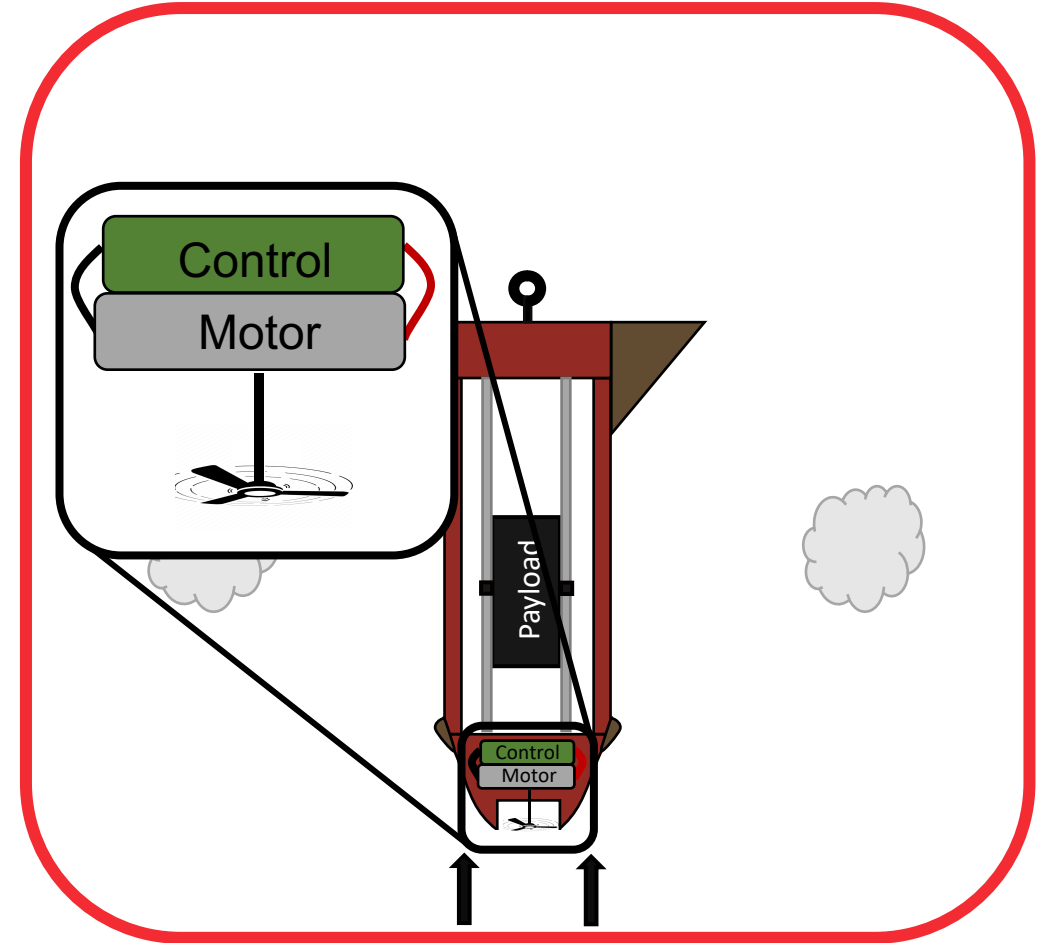

Collin Gainer

Selected Design: Ducted Fan

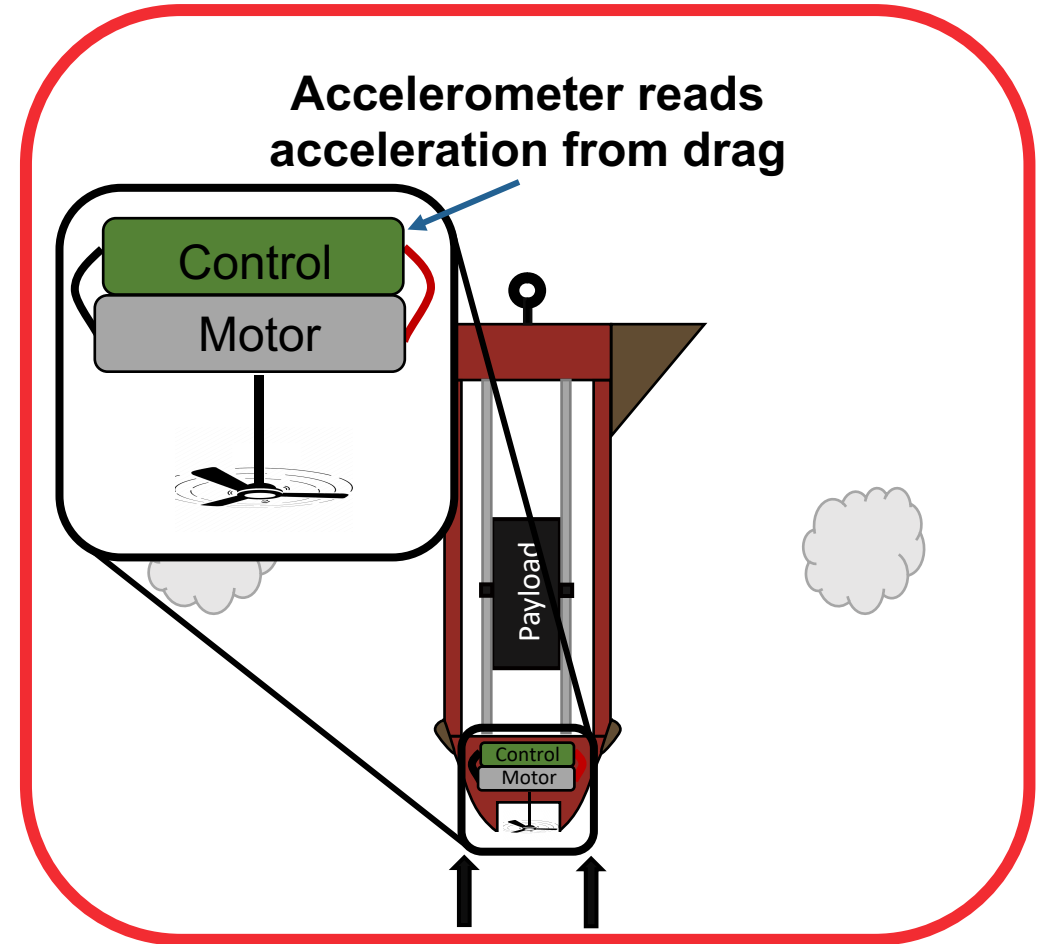

Collin Gainer

Selected Design: Ducted Fan

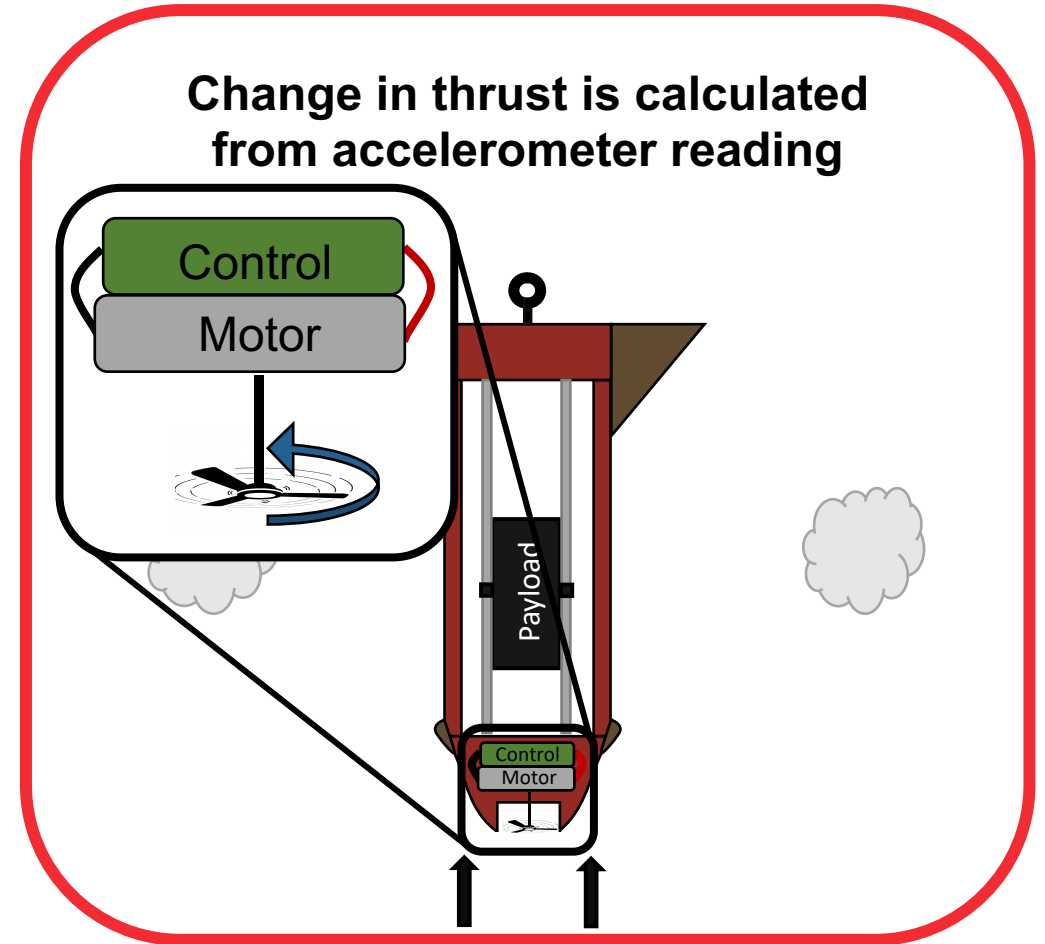

Collin Gainer

Selected Design: Ducted Fan



Air is pulled in by the fan and expelled from nozzles

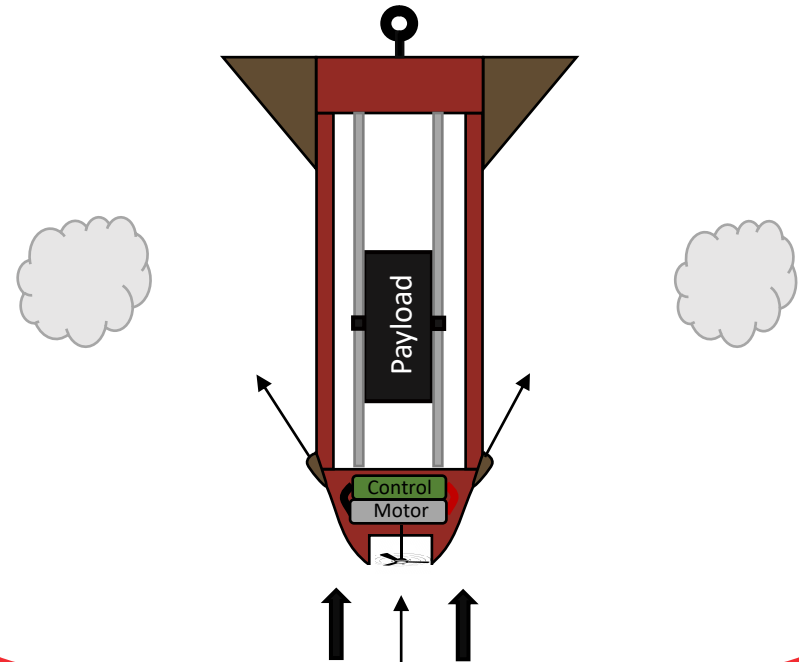

Collin Gainer

Selected Design: Ducted Fan

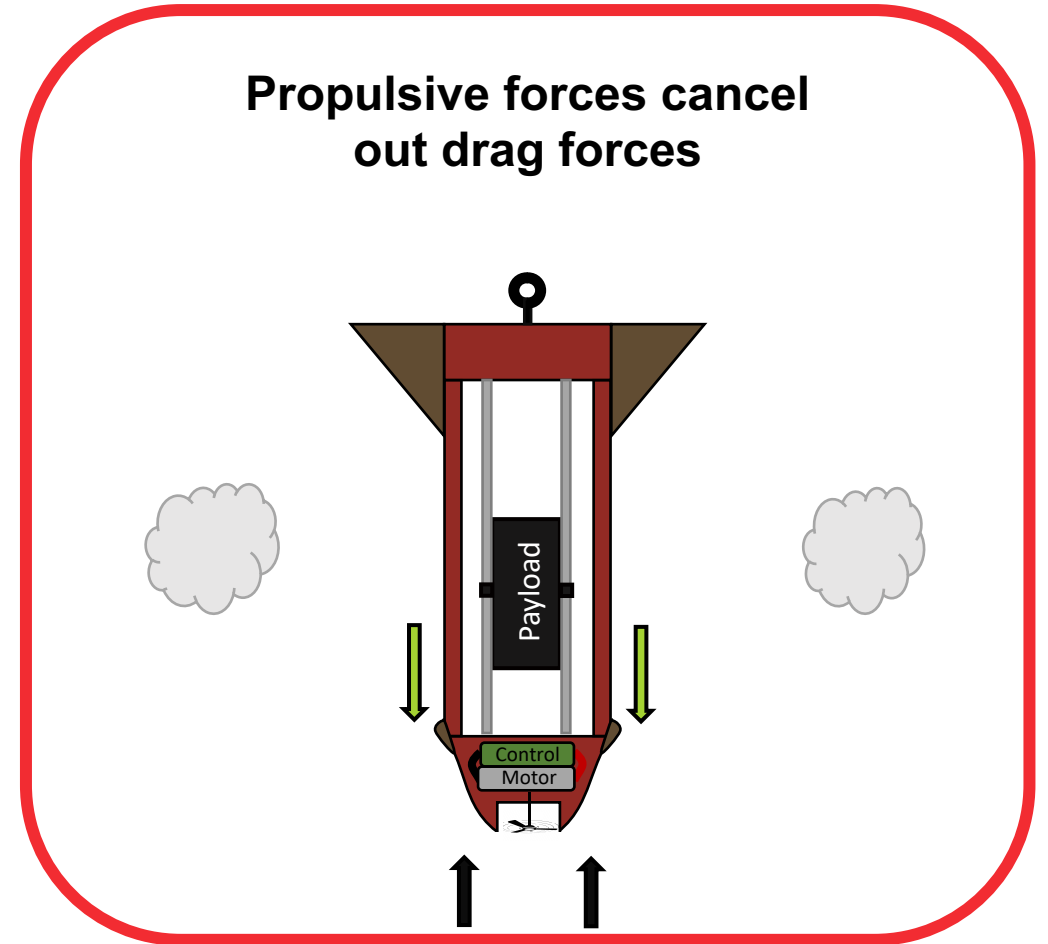

Collin Gainer

Selected Design: Ducted Fan



Controller continuously reevaluates thrust for 4 seconds

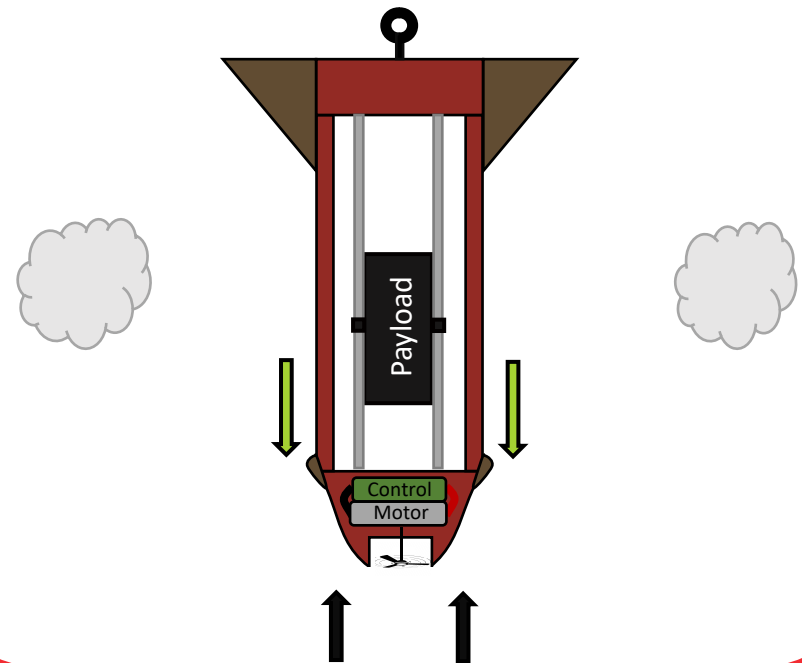

Collin Gainer

Selected Design: Ducted Fan

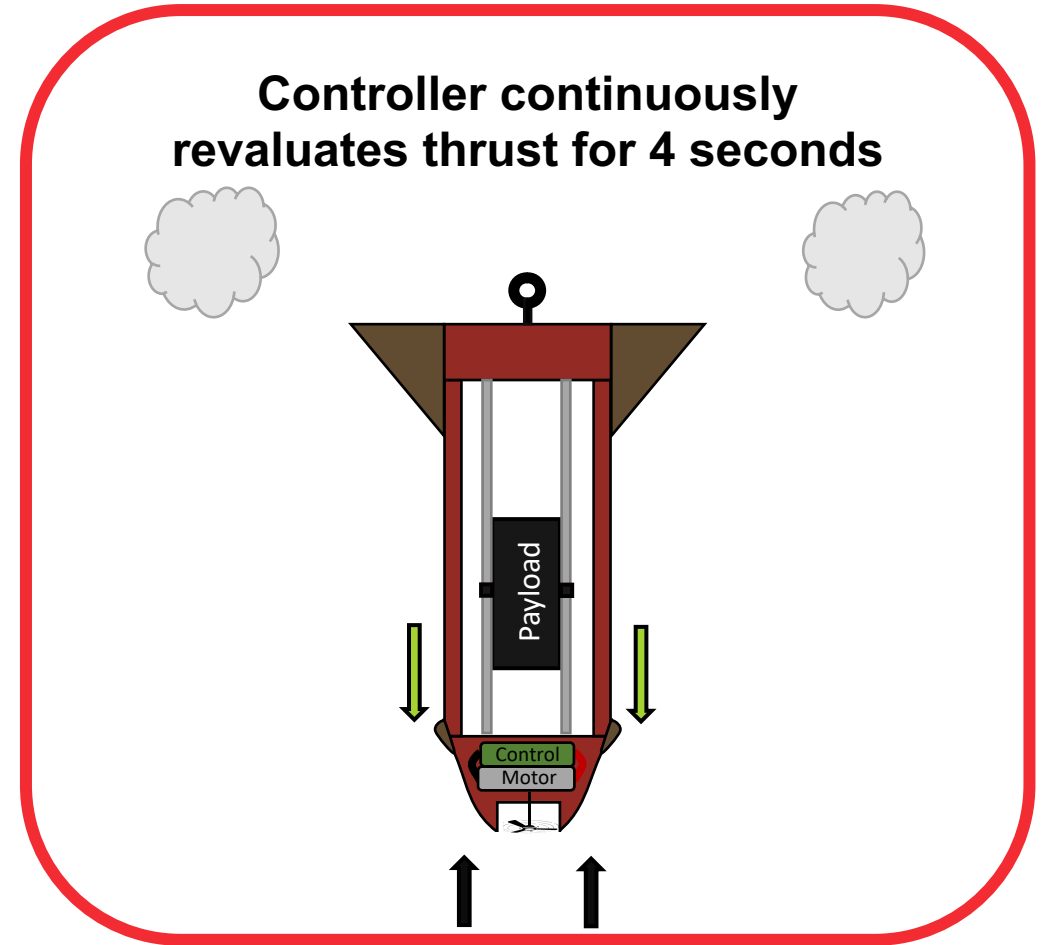

Collin Gainer

Selected Design: Ducted Fan

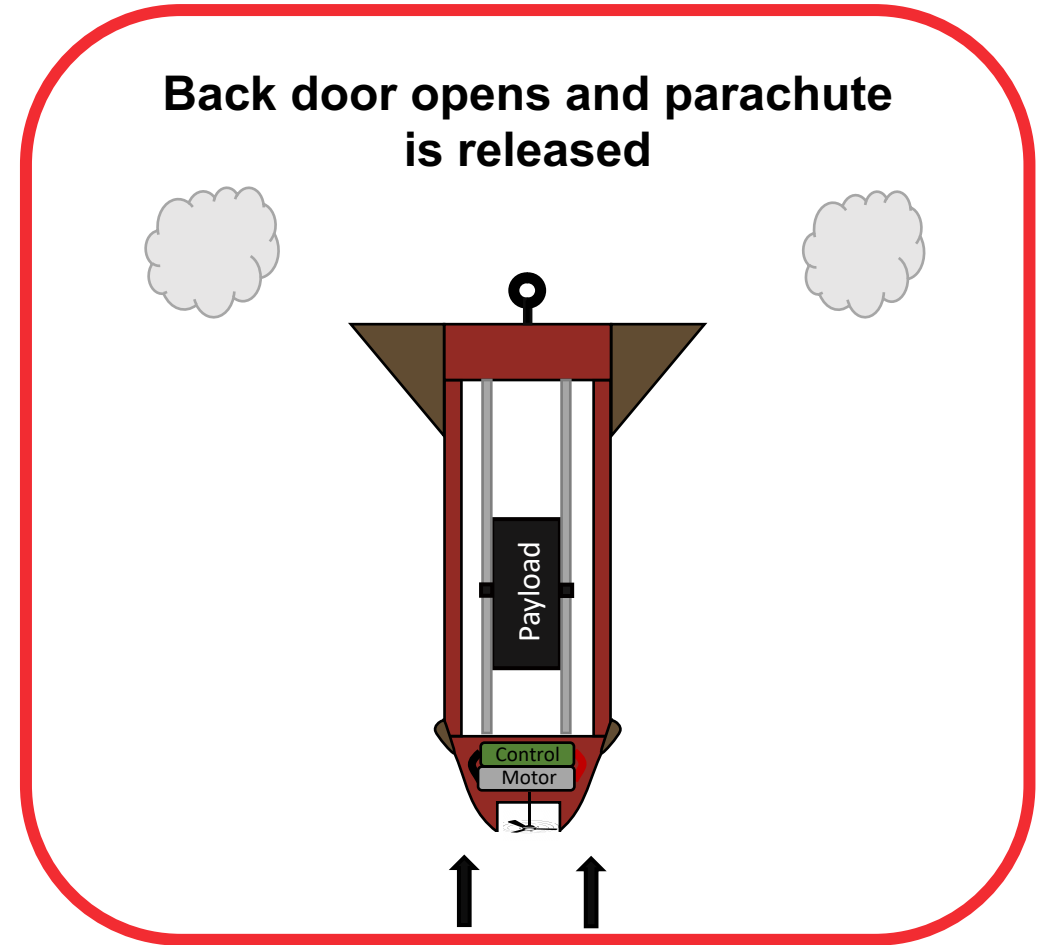

Collin Gainer

Selected Design: Ducted Fan

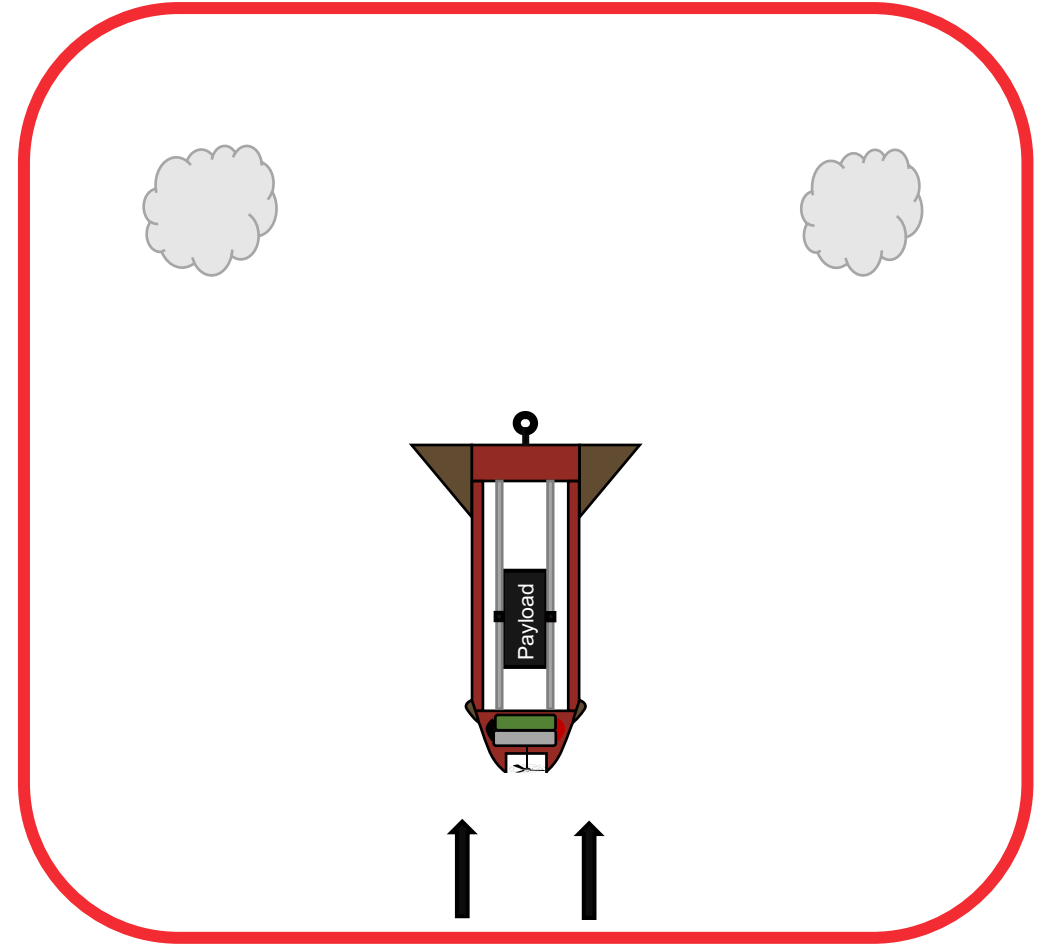

Collin Gainer

Selected Design: Ducted Fan

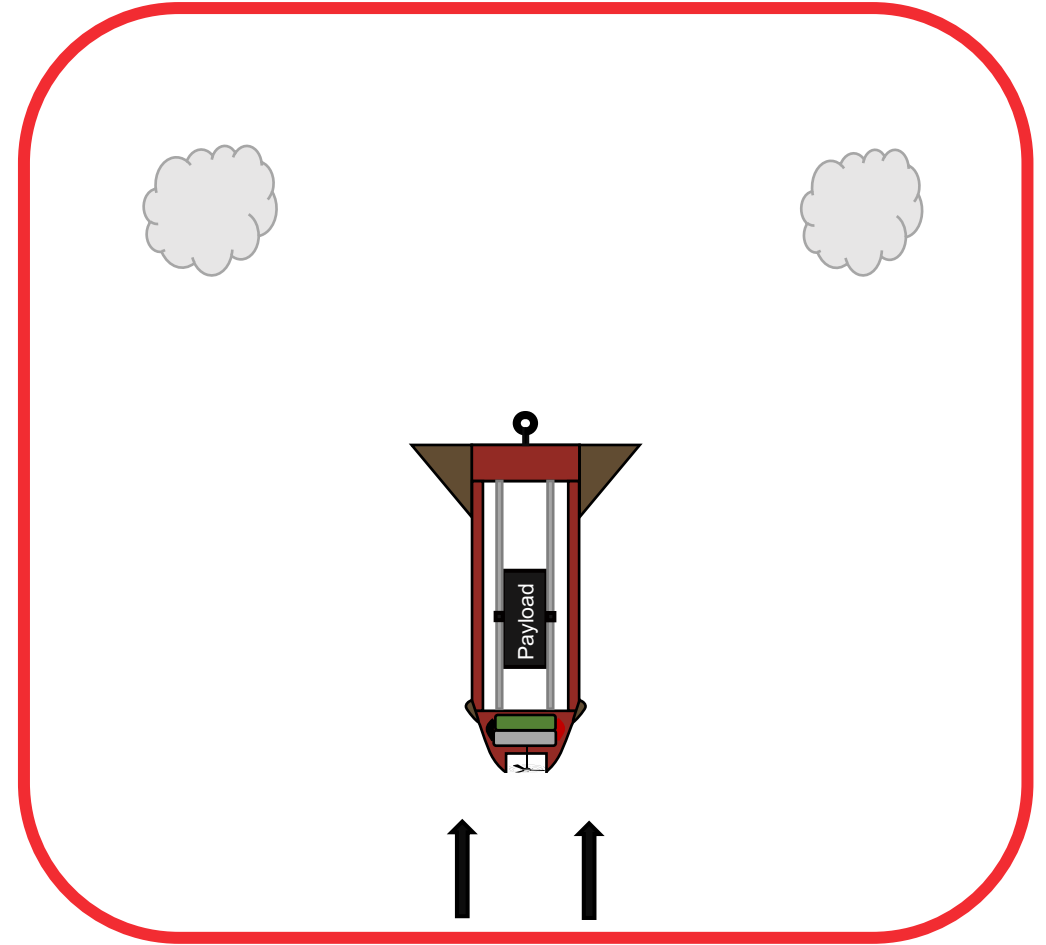

Collin Gainer

Selected Design: Ducted Fan

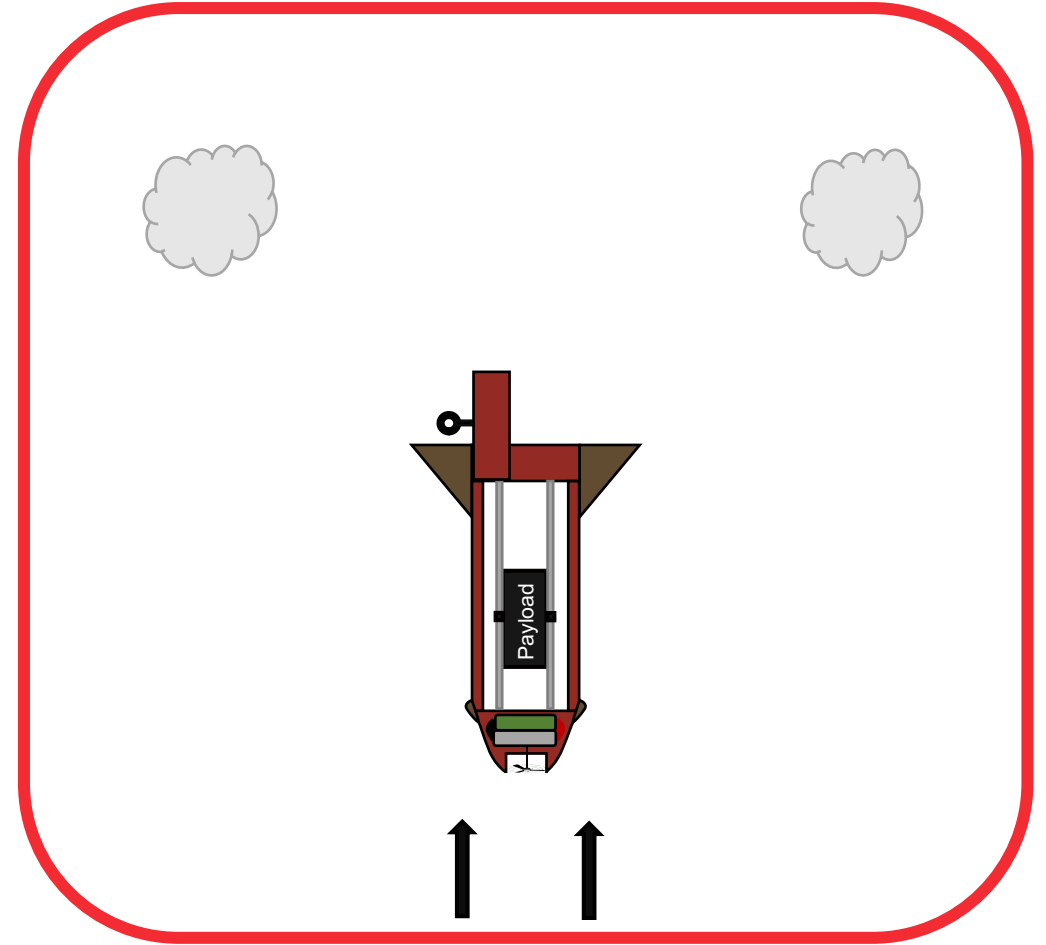

Collin Gainer

Selected Design: Ducted Fan

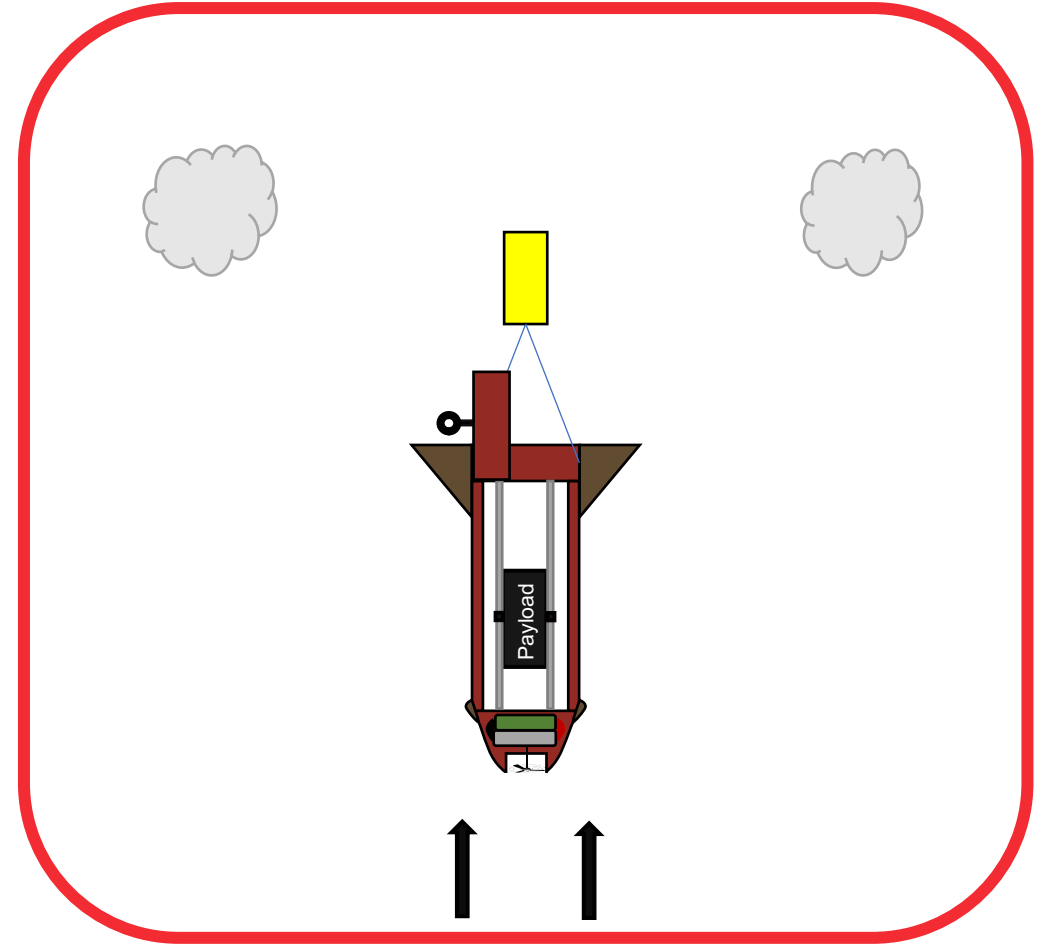

Collin Gainer

Selected Design: Ducted Fan

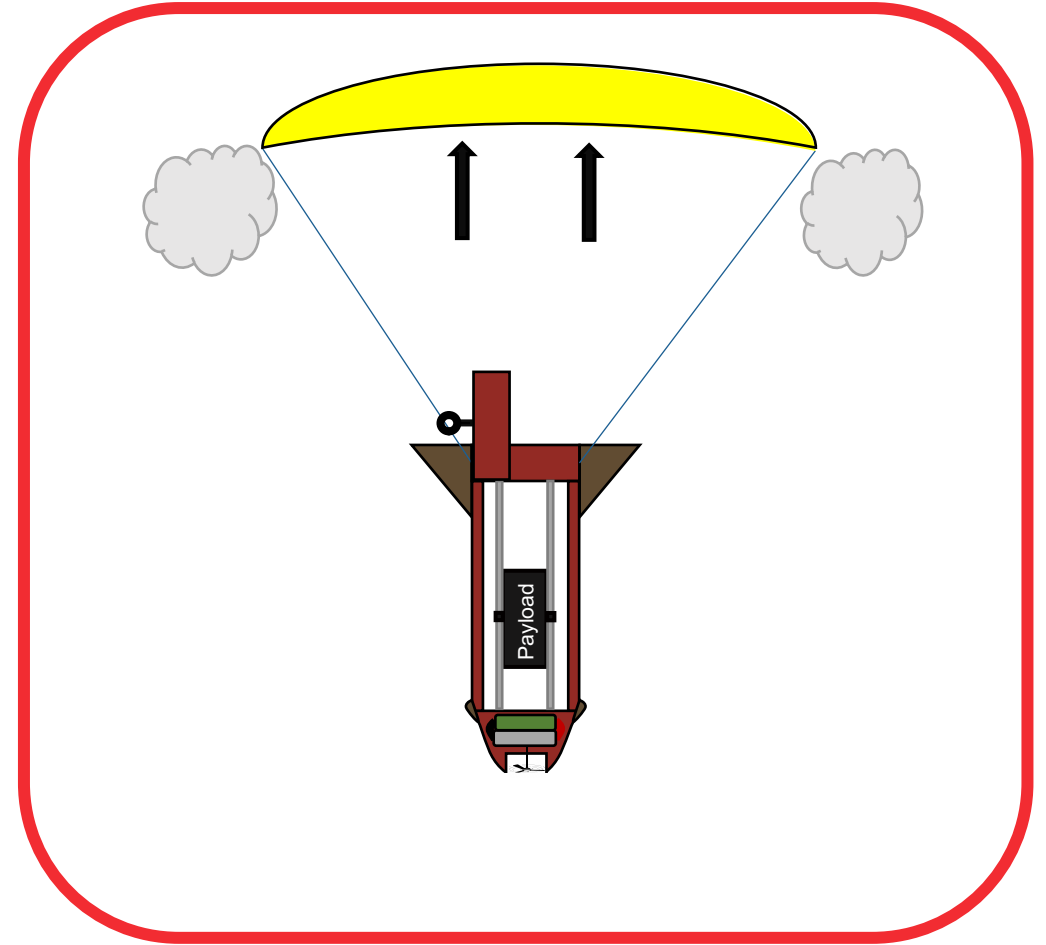

Collin Gainer

Front View

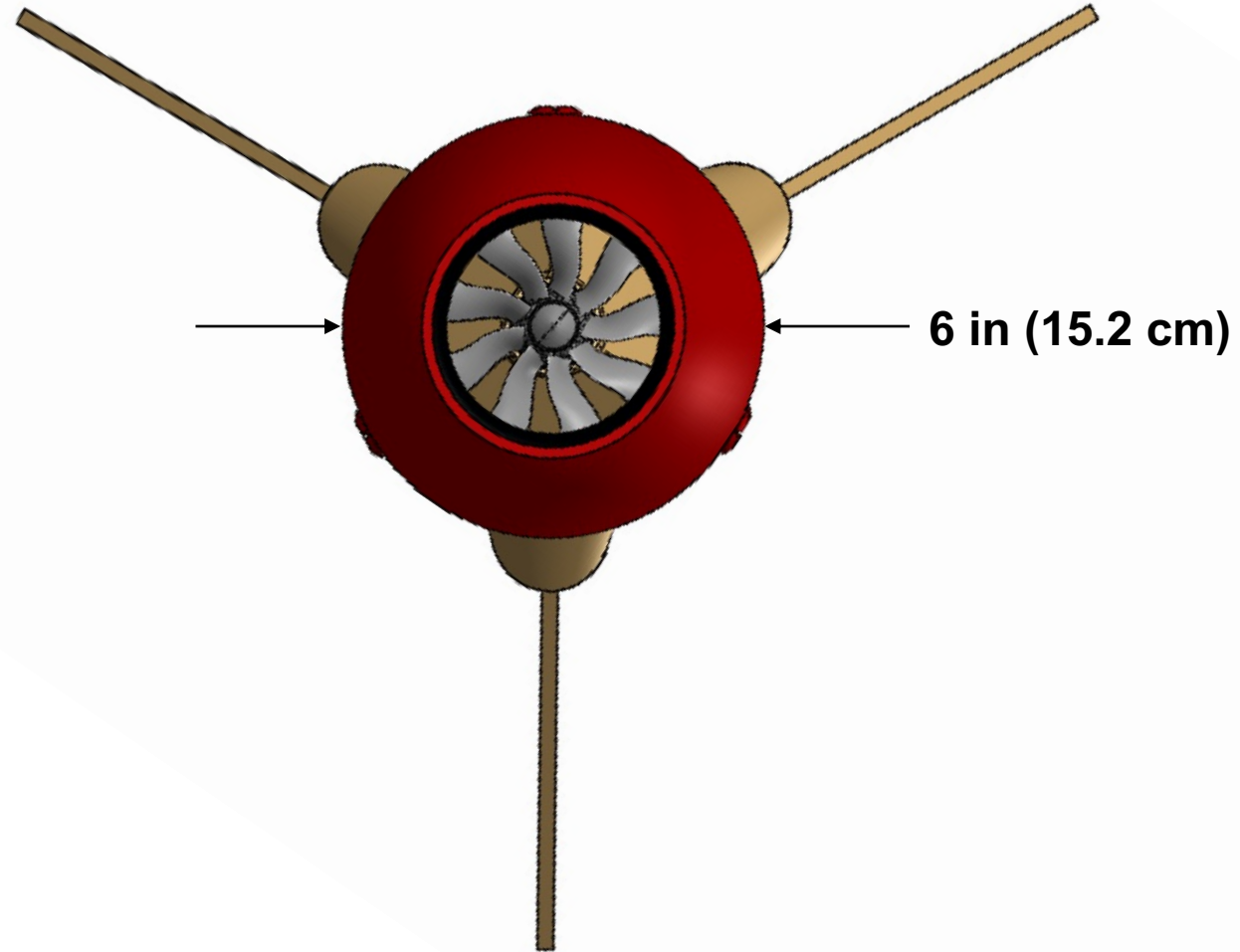

Collin Gainer

Side View

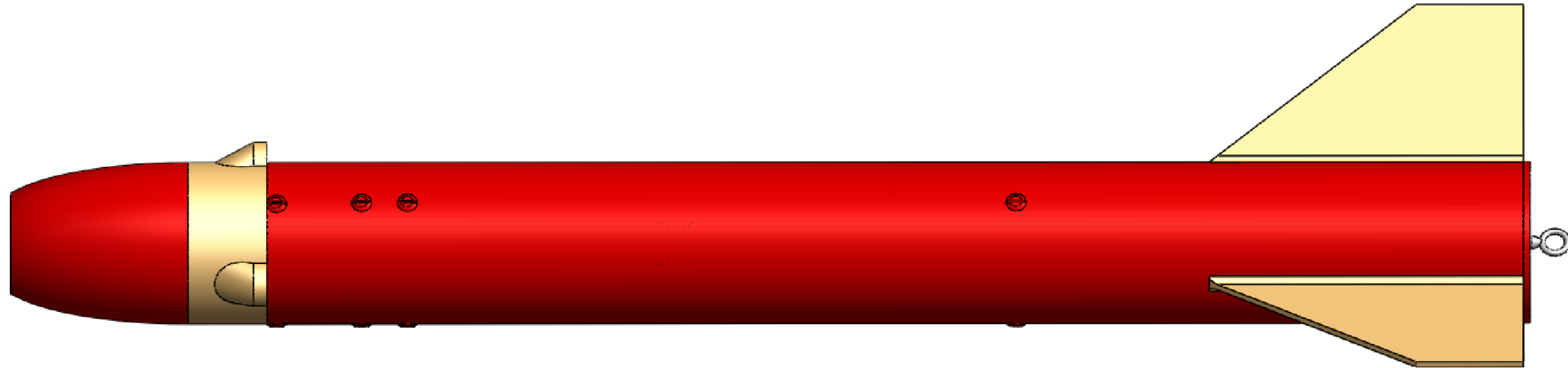

Collin Gainer

Side View

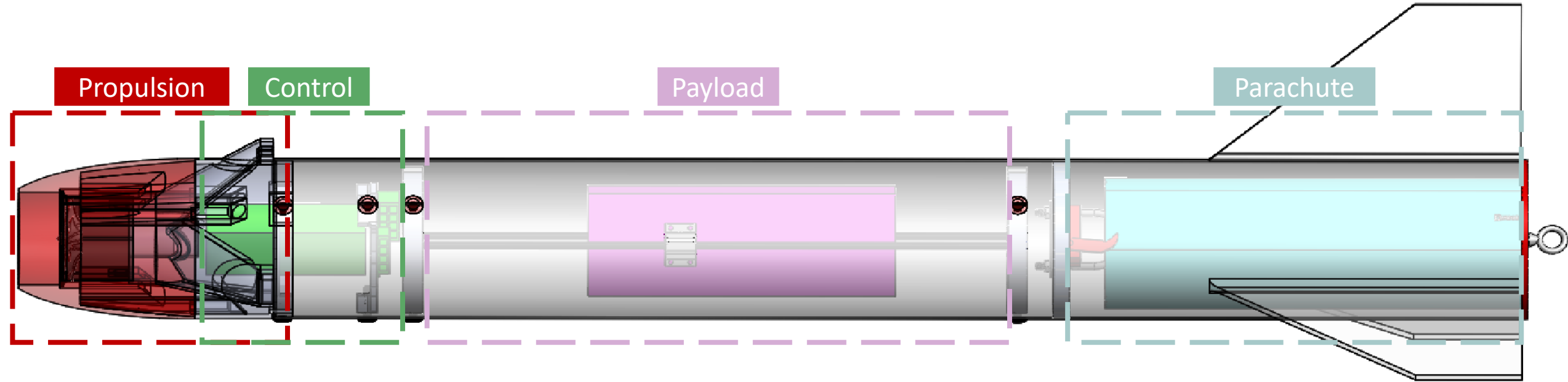

Collin Gainer

Parachute Storage

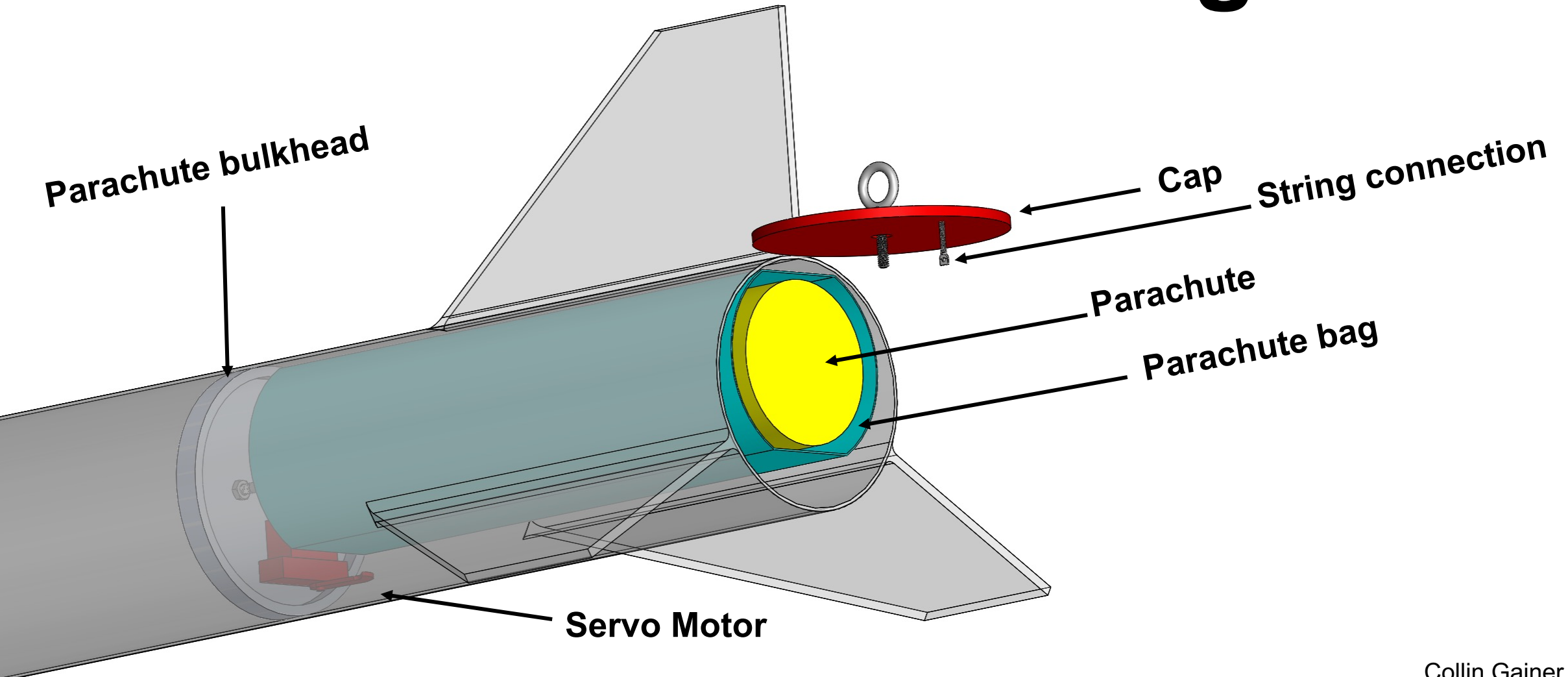

Collin Gainer

Propulsion System

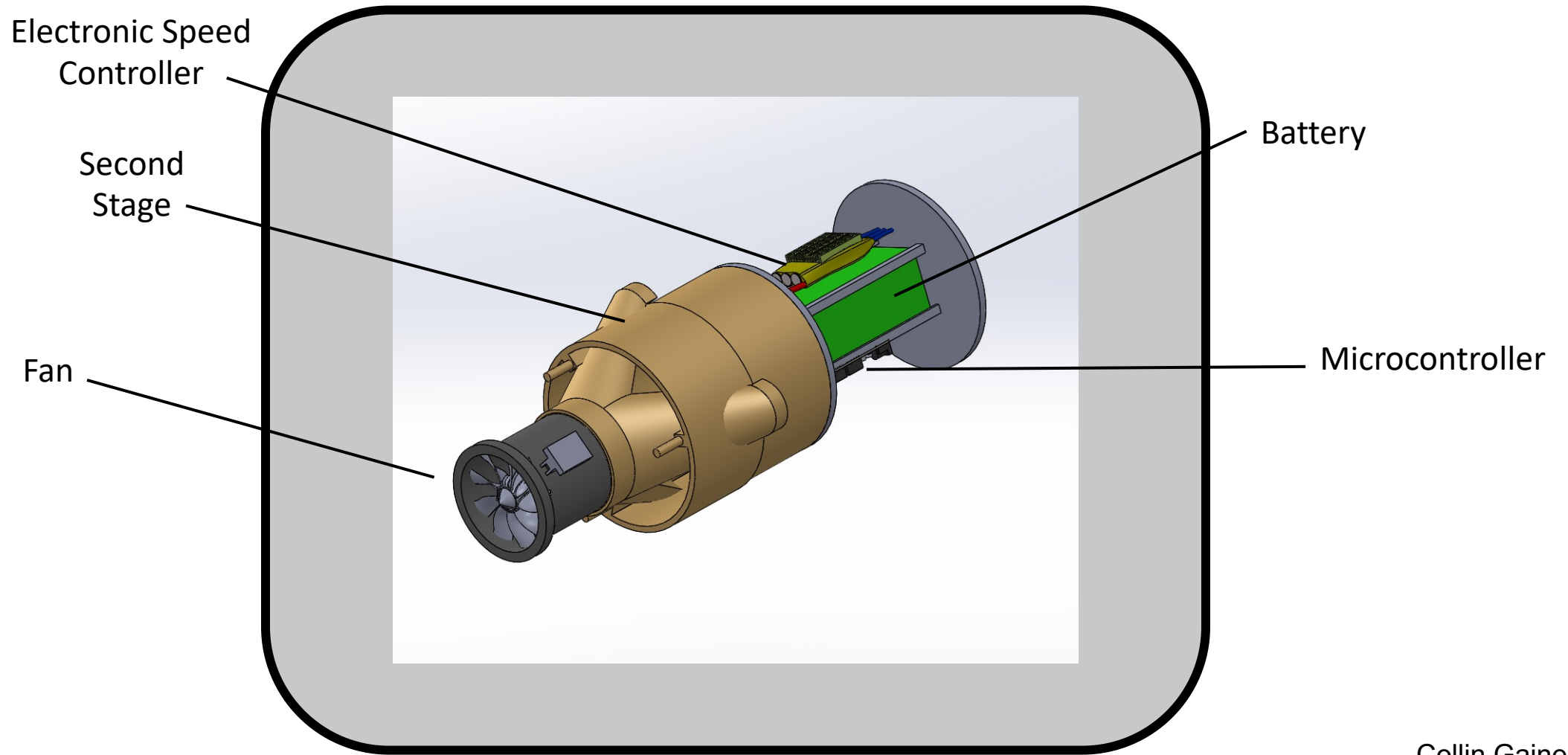

Collin Gainer

Current Work



Selected & Ordered
Parts



Updated
CAD

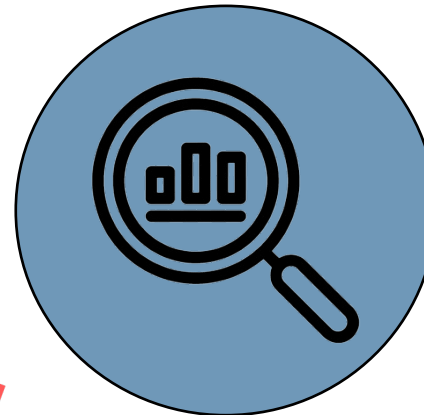

CFD
Analysis

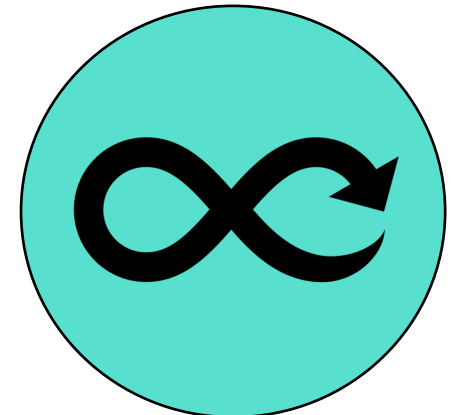

Controls
Code

Collin Gainer

Uncontrolled Simulation

1st portion: Vehicle falls under gravity with drag acting on it.

2nd portion: Vehicle slows after parachute is released

$V \approx 4 \text{ m/s}$ 0.5 s after the parachute is opened

John Tietsworth

Uncontrolled Simulation

1st portion: Vehicle falls under gravity with drag acting on it.

2nd portion: Vehicle slows after parachute is released

$V \approx 4 \text{ m/s}$ 0.5 s after the parachute is opened

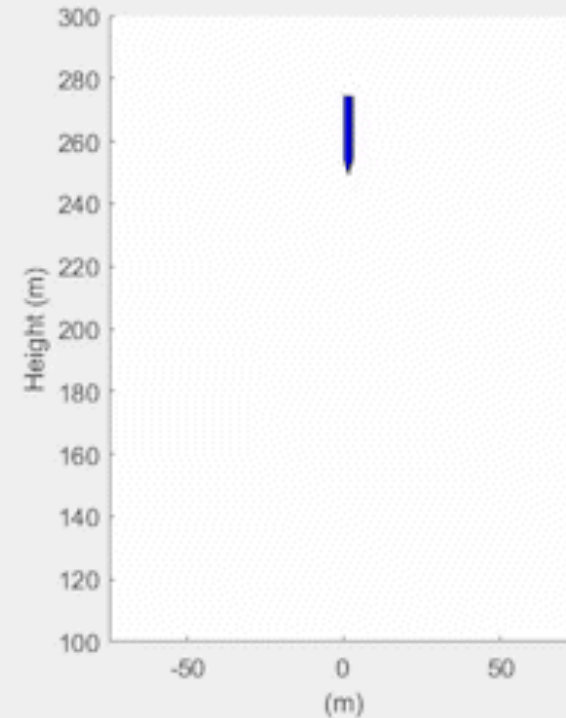

John Tietsworth

Controlled Simulation (PID)

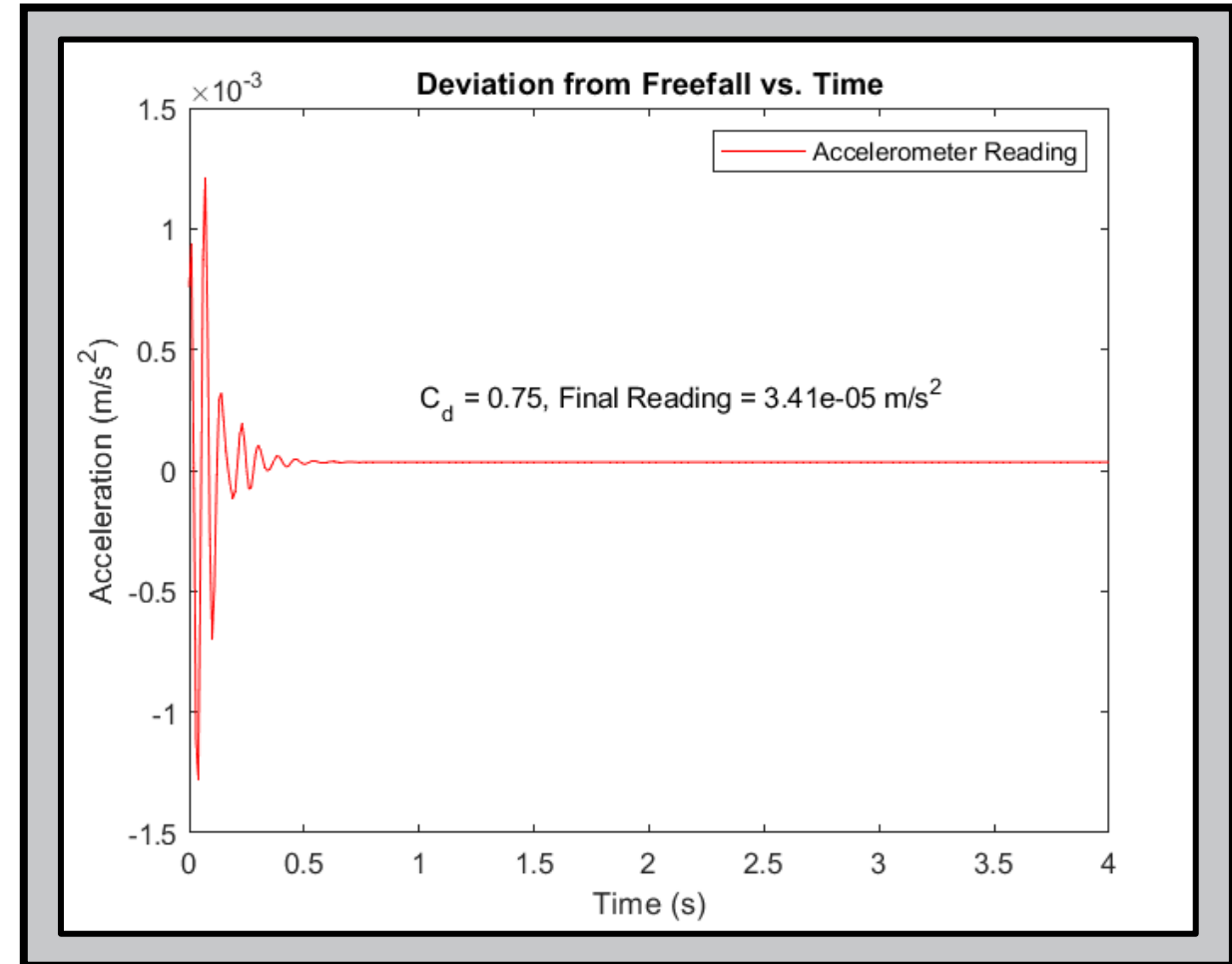
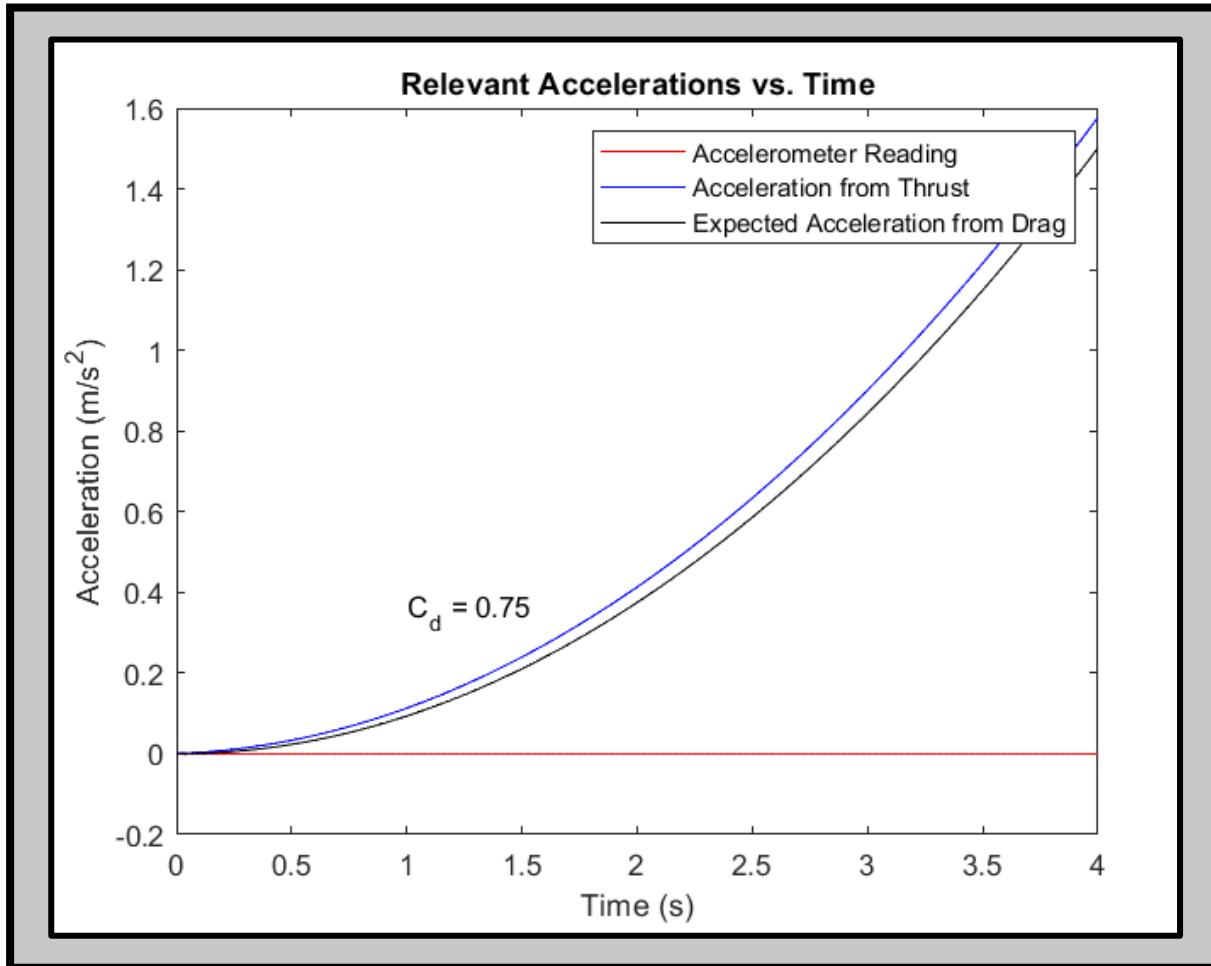

John Tietsworth

Budget

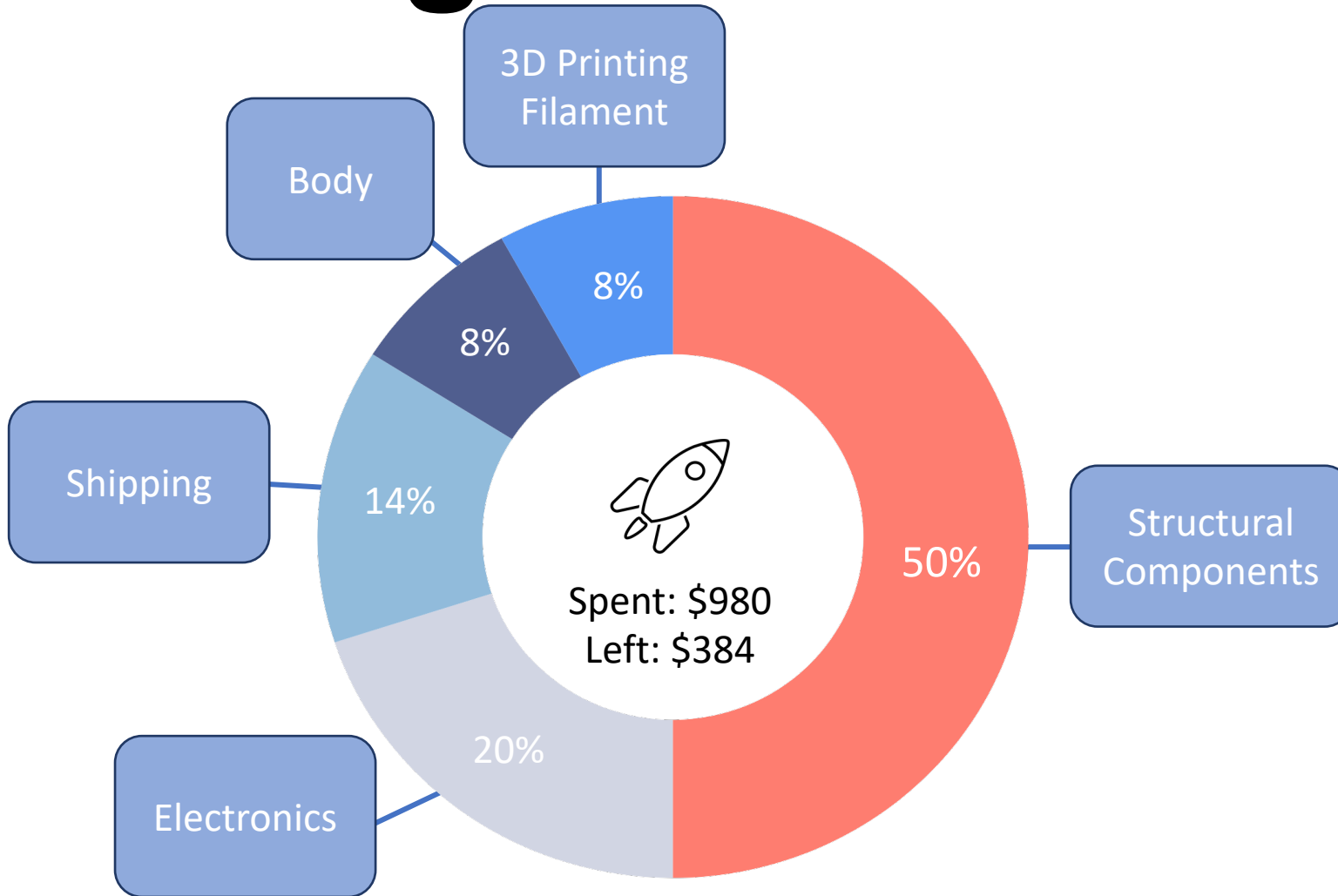

3D Printing Filament



Body



Shipping



Electronics

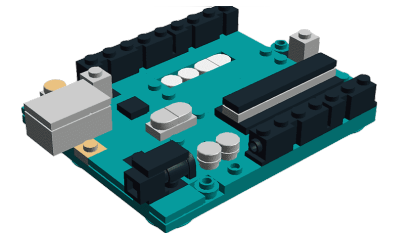

Structural Components



John Tietsworth

Testing Plans

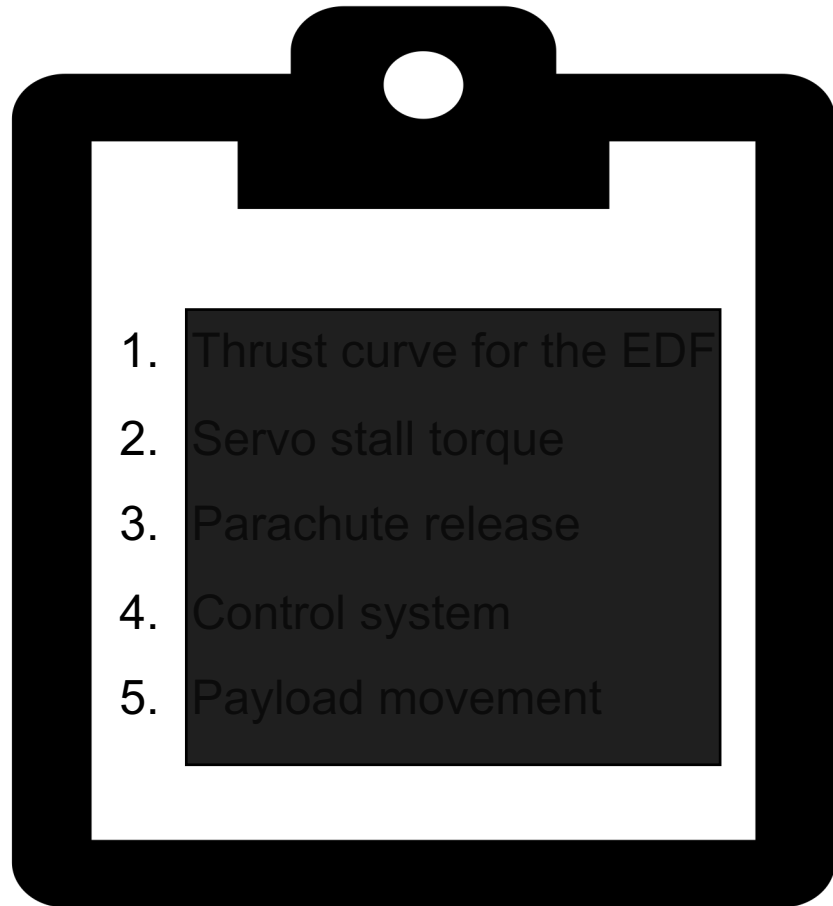

John Tietsworth

Testing Plans

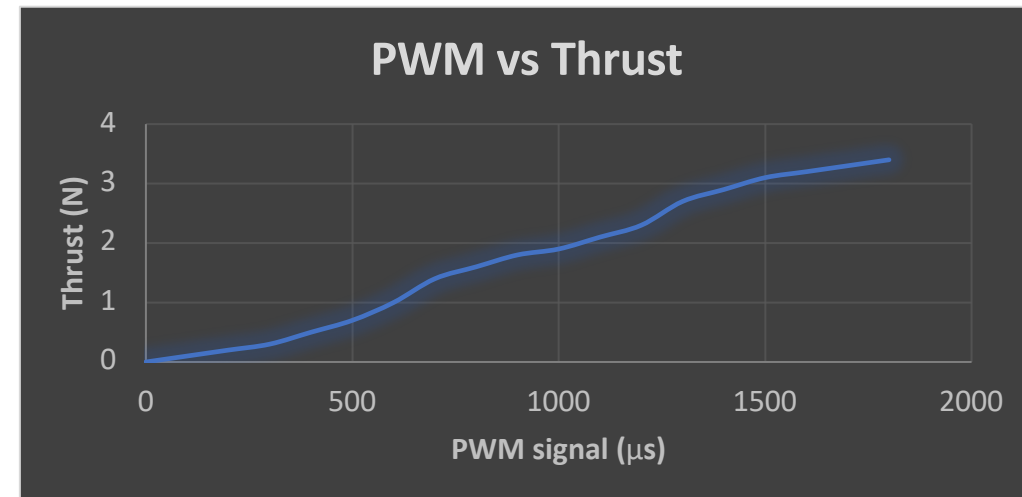
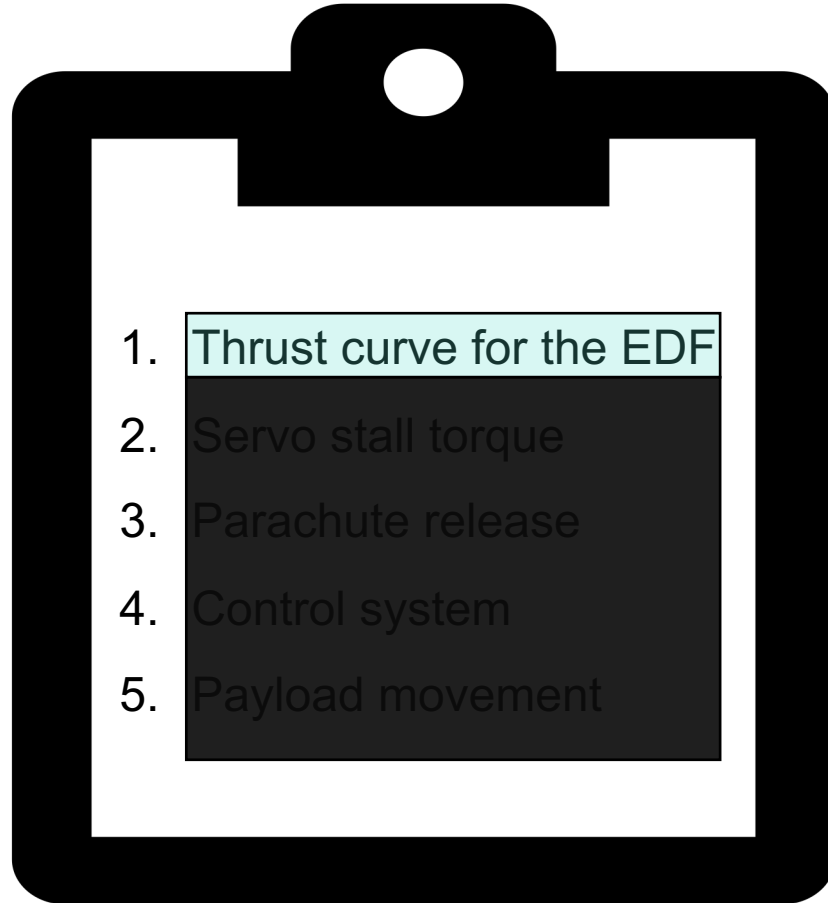

John Tietsworth

Testing Plans

1. Thrust curve for the EDF
2. Servo stall torque
3. Parachute release
4. Control system
5. Payload movement



John Tietsworth

Testing Plans

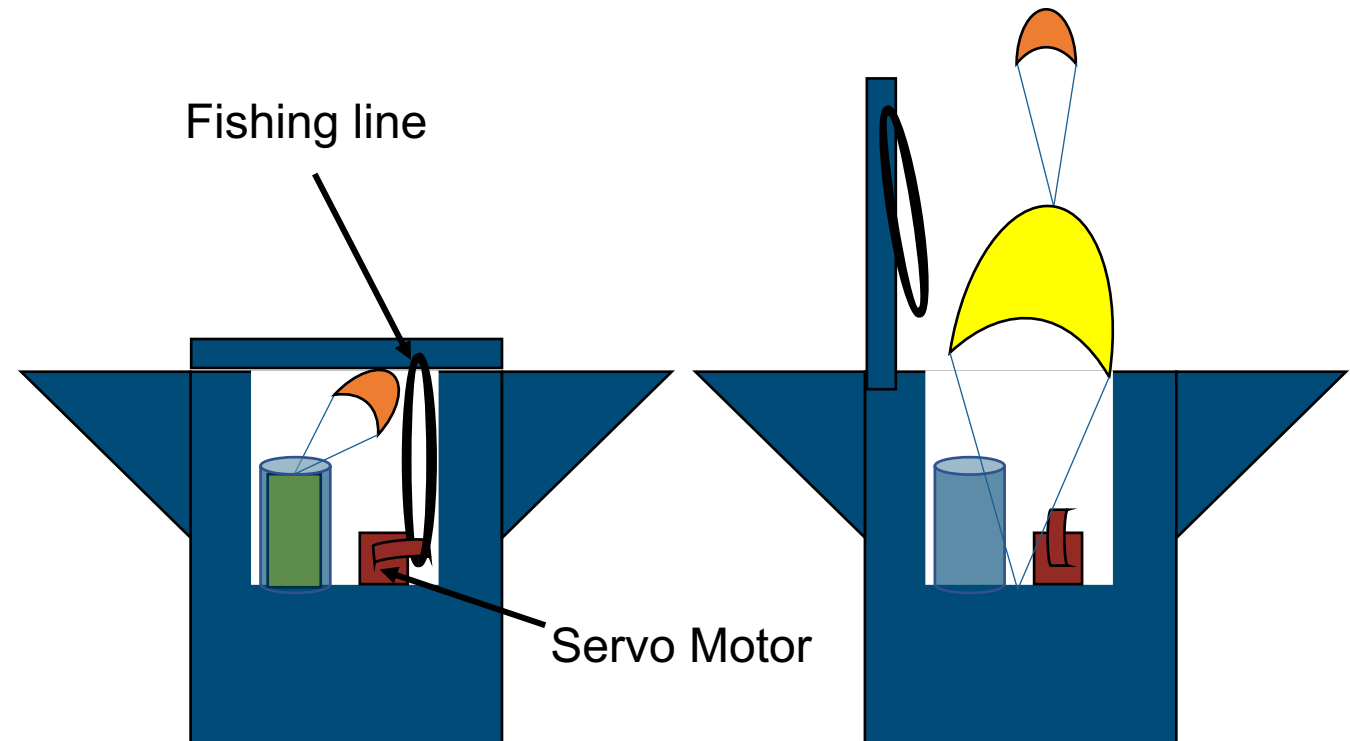
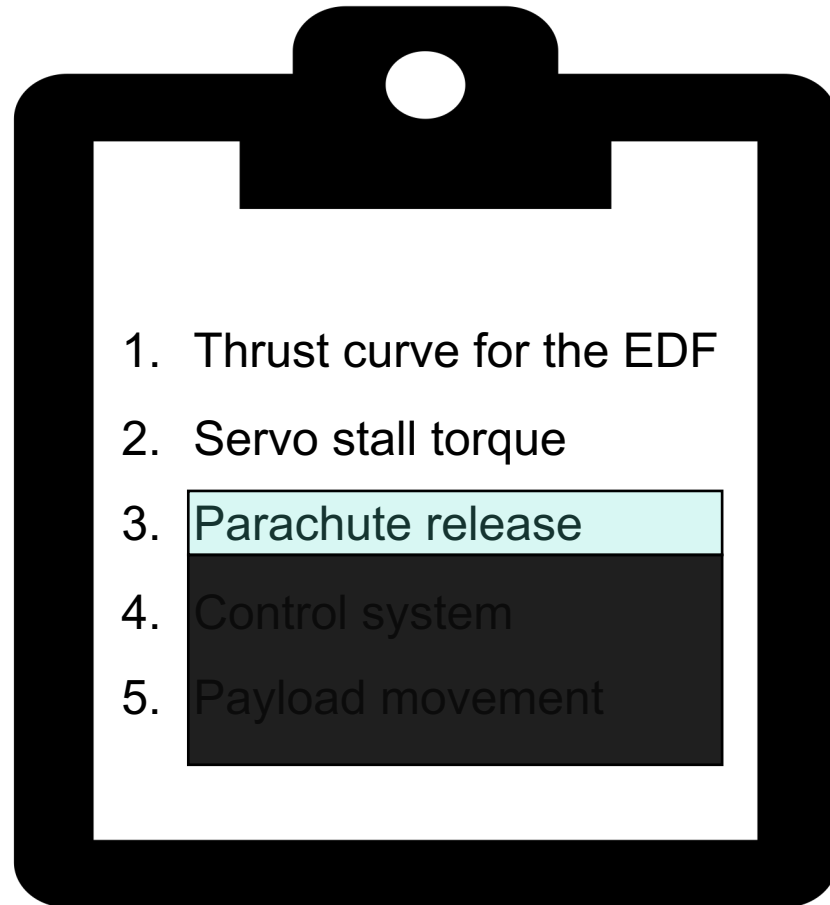

John Tietsworth

Testing Plans

1. Thrust curve for the EDF
2. Servo stall torque
3. Parachute release
4. Control system
5. Payload movement

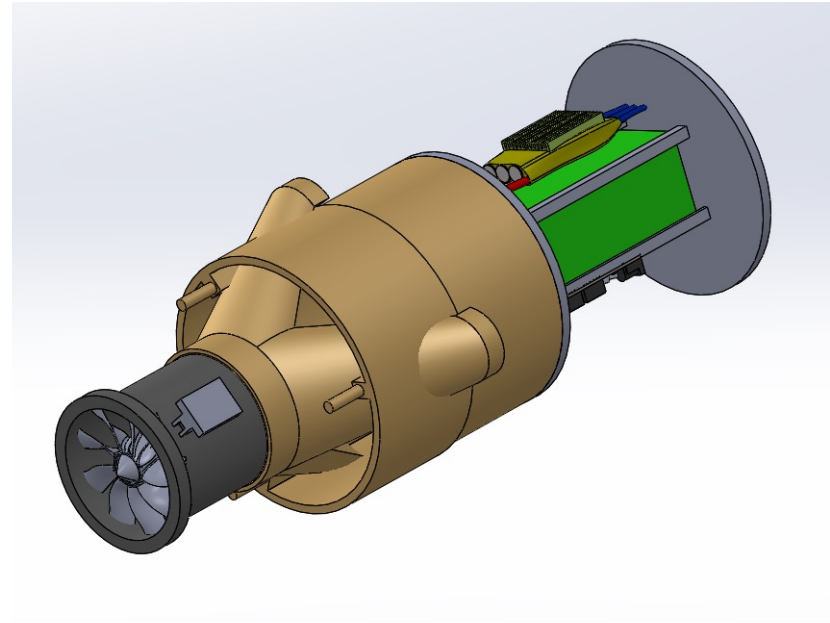

John Tietsworth

Testing Plans

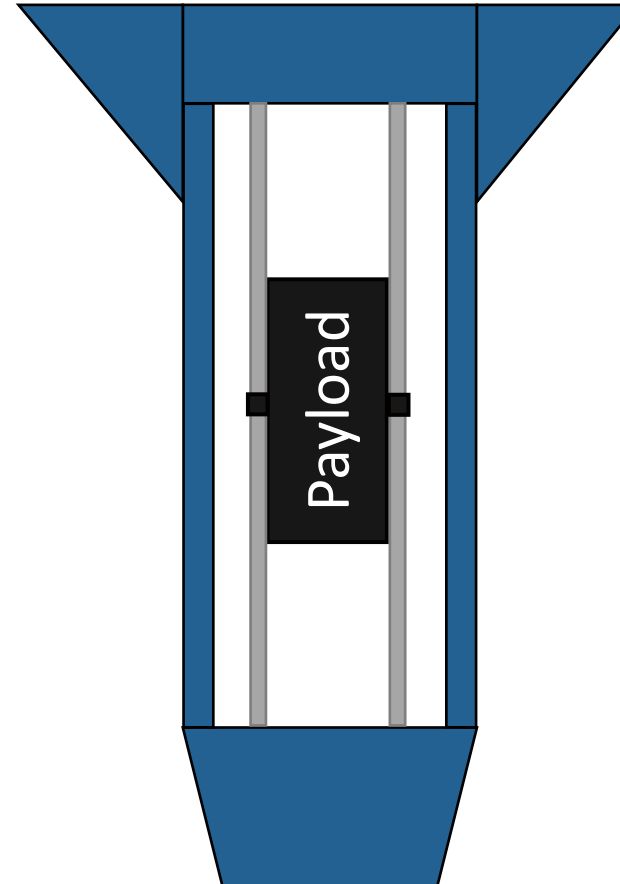
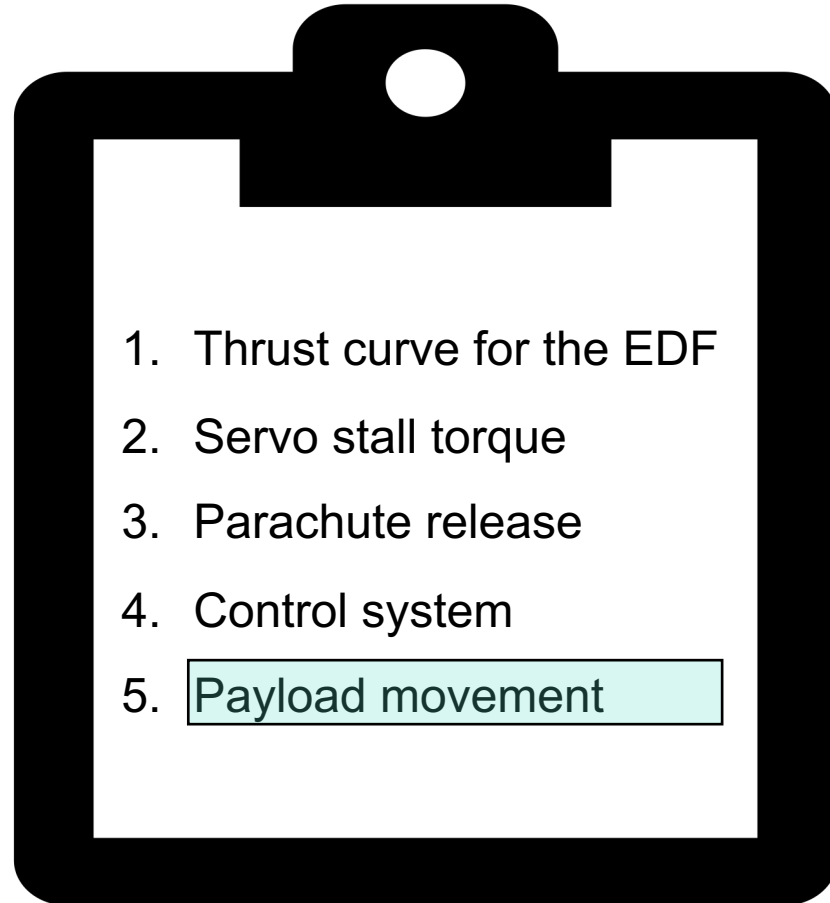

John Tietsworth

Future Work



SUBSYSTEM TESTING



ASSEMBLY

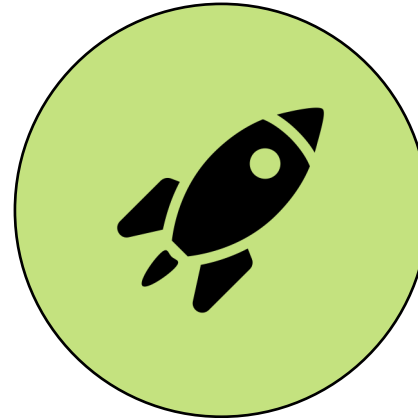

FULLSCALE TESTING

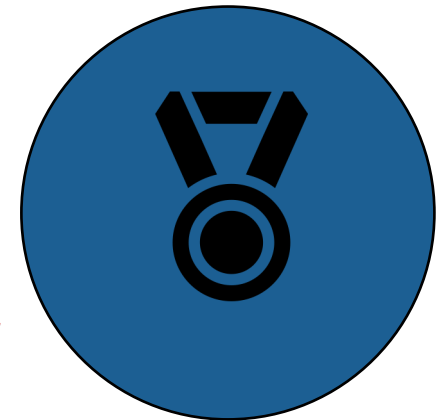

COMPETITION

John Tietsworth

References

Images:

<https://thekidshouldseethis.com/post/feathered-fighter-jets-peregrine-falcons>

https://www.esa.int/ESA_Multimedia/Images/2007/11/Zero-G_Airbus_A300_for_parabolic_flights

https://en.wikipedia.org/wiki/Sounding_rocket

https://www.esa.int/ESA_Multimedia/Images/2017/03/ZARM_s_Drop_Tower_in_Bremen

<https://www.hitec.uni-hannover.de/en/large-scale-equipment/einstein-elevator/>

<https://www.hitec.uni-hannover.de/en/large-scale-equipment/einstein-elevator/events-and-media/>

Further Readings:

<https://www.gozerog.com/>

https://www.nasa.gov/mission_pages/sounding-rockets/missions/index.html

<https://www.zarm.uni-bremen.de/en/drop-tower/general-information.html>

<https://www.hitec.uni-hannover.de/en/large-scale-equipment/einstein-elevator>

https://www.youtube.com/watch?v=4aCMDQsx740&ab_channel=TomScott

John Tietsworth