

Shear Strength of Soil

By

Kamal Tawfiq

Fall 2019

Shear Strength

Questions:

What are the stress vs. strain relationships for materials ?????????? Pick strength

- *Linear Elastic*
- *Nonlinear Elastic*
- *Elastic Plastic*
- *Plastic*
- *Rigid Plastic*

What is the strength of any material ??????????
Upper limit of the stress – Strain relationship

Why shear strength in soil ??????????
Compressive strength of soil is good
No tensile strength
Shear strength is the most critical

Two types of Soil when it comes to stress vs. strain relationships

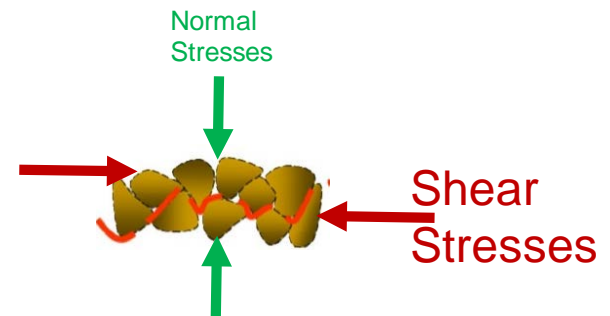
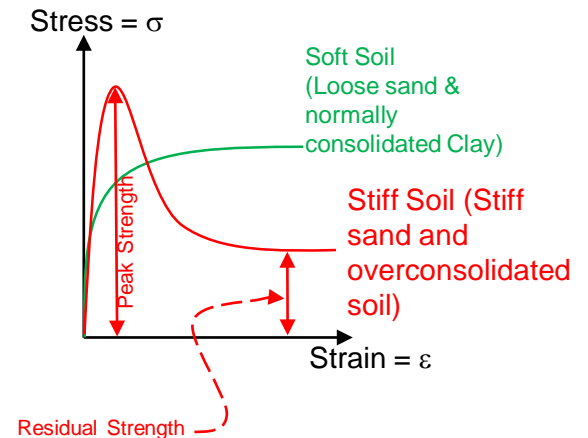

Soil Shear Strength

What is shear strength ????

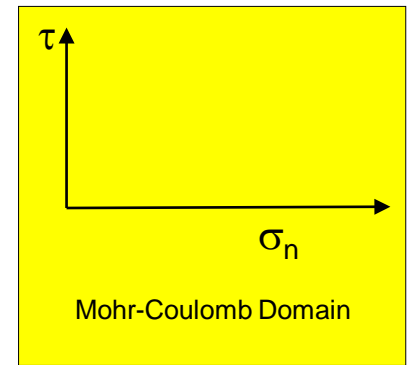

Soil is weak in shear

To determine the shear strength of soil Mohr-Coulomb Yield Criterion is used

$$\tau = c + \sigma_n \tan \phi$$

Soil Cohesion

Normal Stress

Angle of Friction

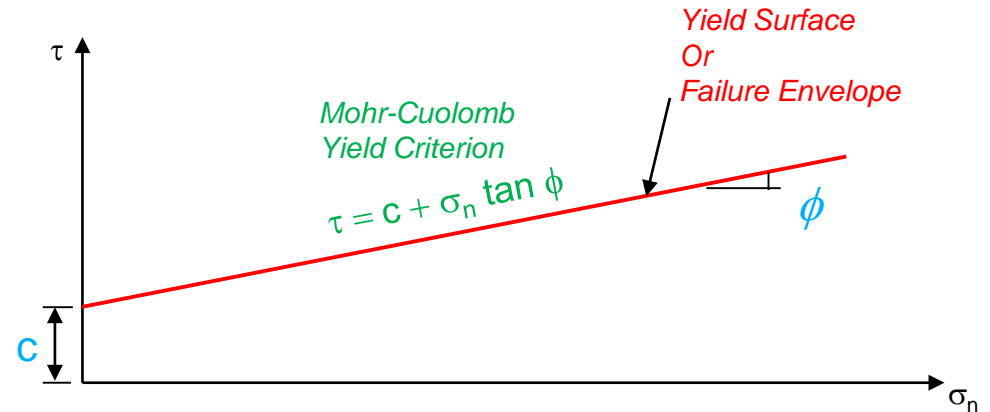

Determination of Soil Strength Parameters (c and φ) in the Lab

1- Direct Shear Test

2- Unconfined Compression Test

3- Triaxial Compression Test

Fine Soils

1- Unconsolidated Undrained Test (UU) – Quick Test – Short Term Analysis

2- Consolidated Undrained Test (CU)

3- Consolidated Drained Test (CD) – Slow Test – Long Term Analysis

I – Direct Shear Test

1- Direct Shear Test

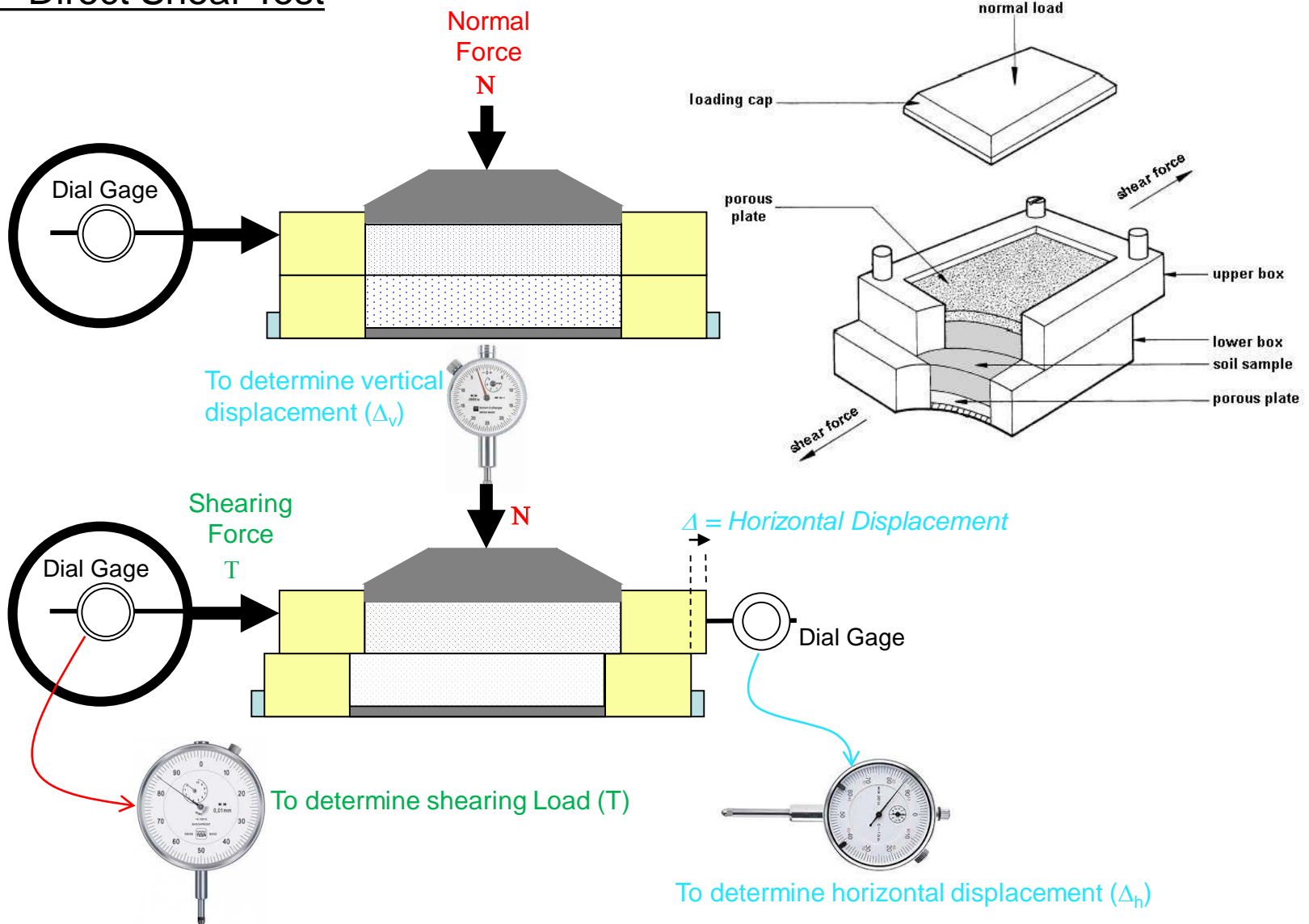

Direct Shear Test

- **Repeat** this test three times.
- Each time increase "N"
- Record σ_n and τ_{max} for each test
- Plot σ_n and τ_{max} for each test
- Fit a straight line through the 3 points
- Find c and ϕ

Shearing Force = T

Normal Force = N

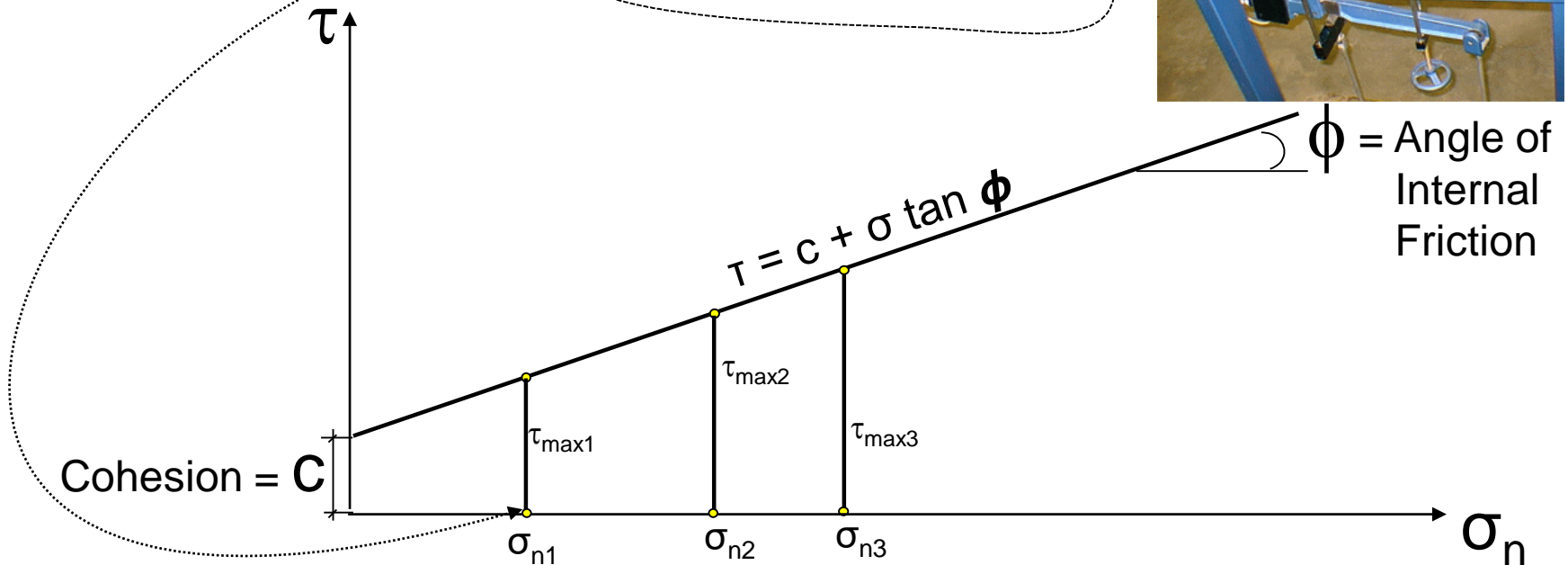
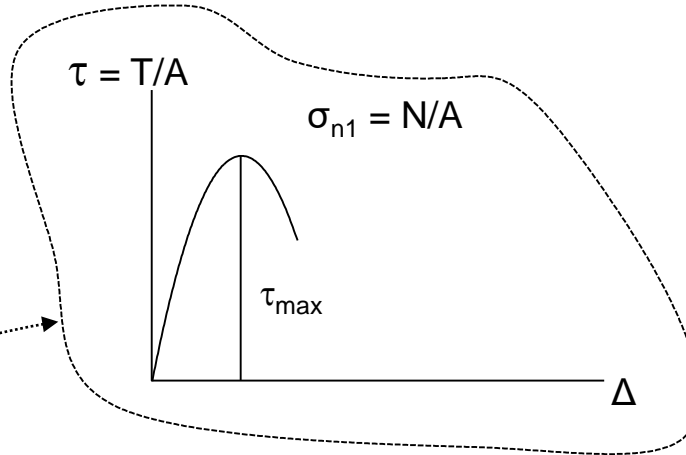
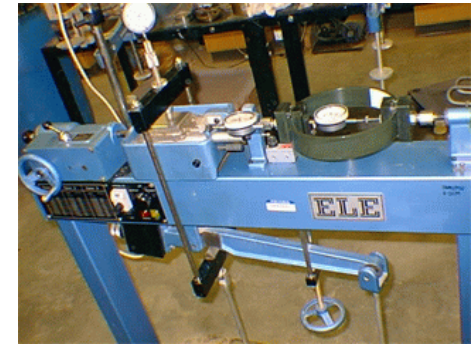
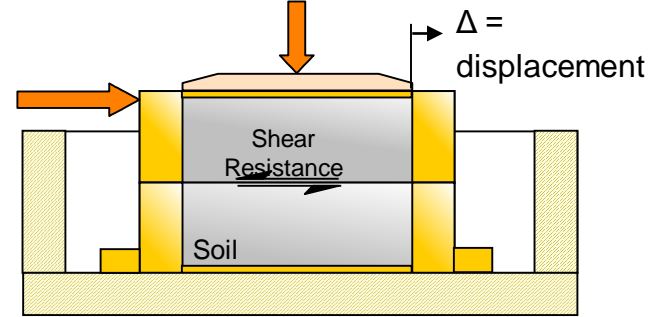

Direct Shear Test

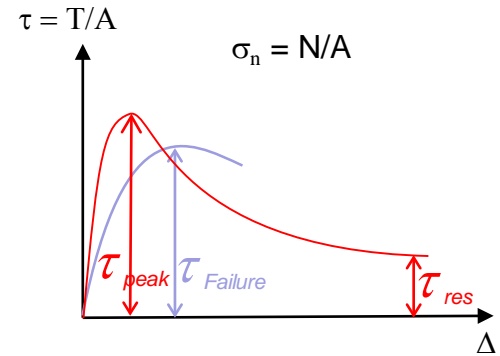
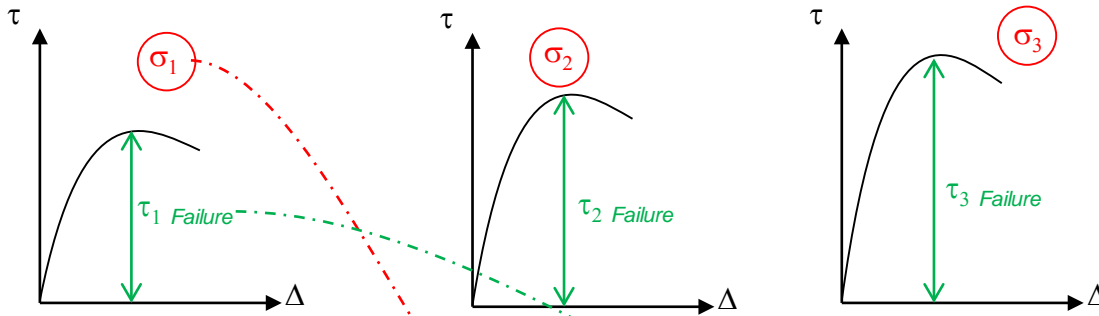

Test #	Normal Stress (σ_n)	Shear at Failure (τ)
1	σ_1	τ_1
2	σ_2	τ_2
3	σ_3	τ_3

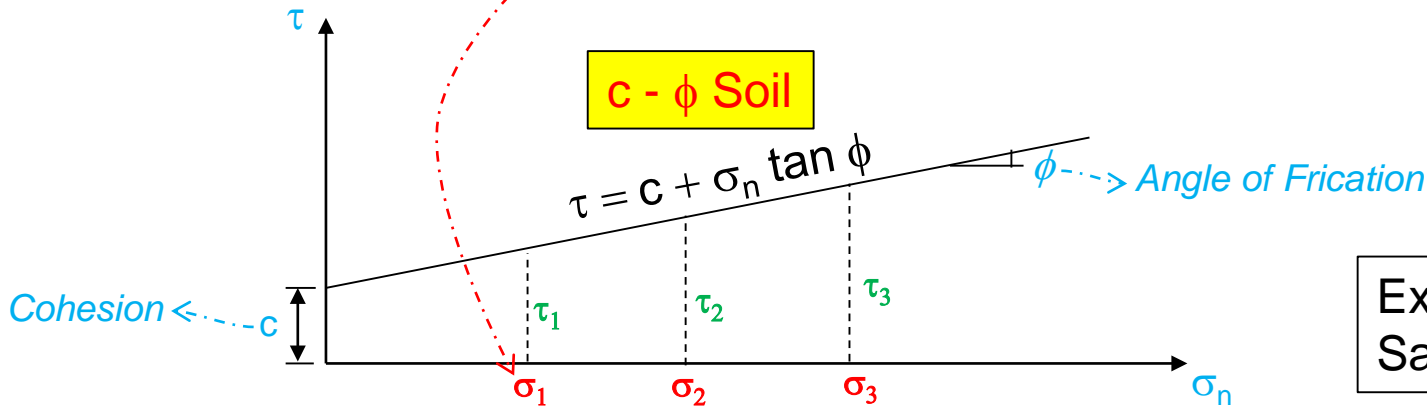

Example:
Sandy - Clay

Direct Shear Test

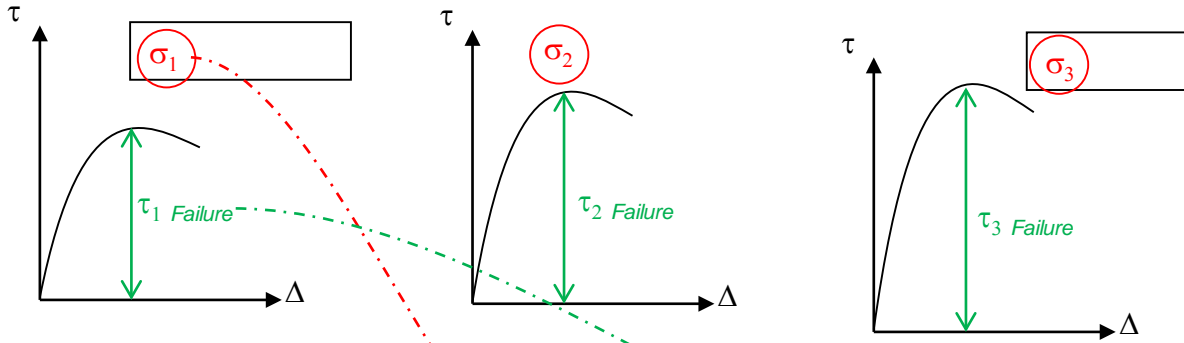

Test #	Normal Stress (σ_n)	Shear at Failure (τ)
1	σ_1	τ_1
2	σ_2	τ_2
3	σ_3	τ_3

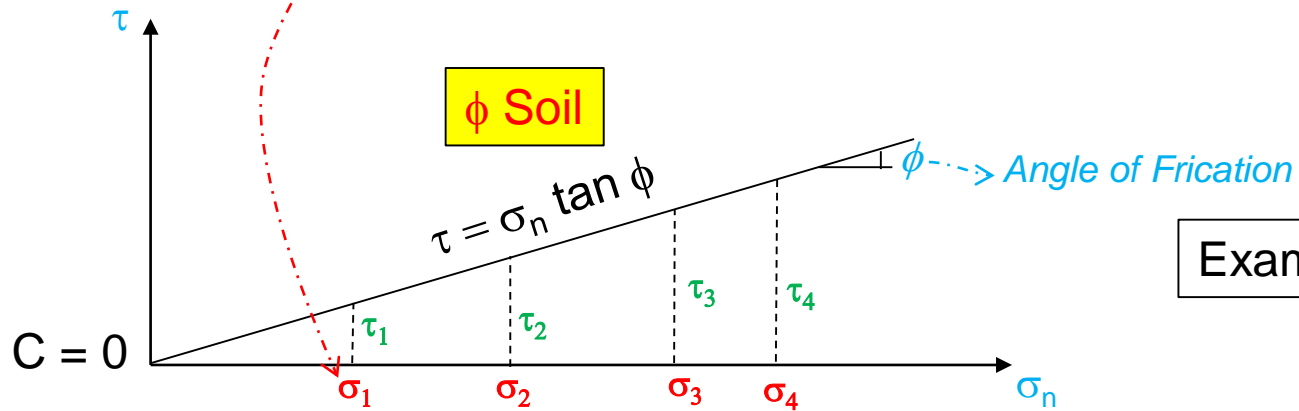

Example: Sand

Direct Shear Test

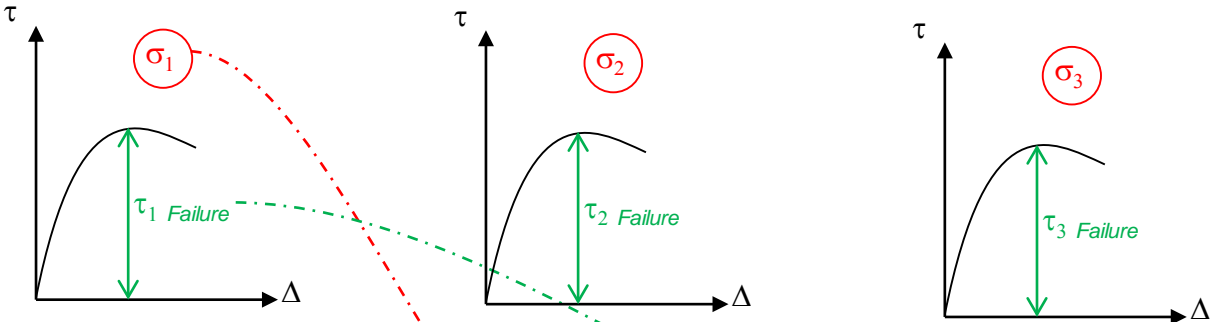

Test #	Normal Stress (σ_n)	Shear at Failure (τ)
1	σ_1	τ_1
2	σ_2	τ_2
3	σ_3	τ_3

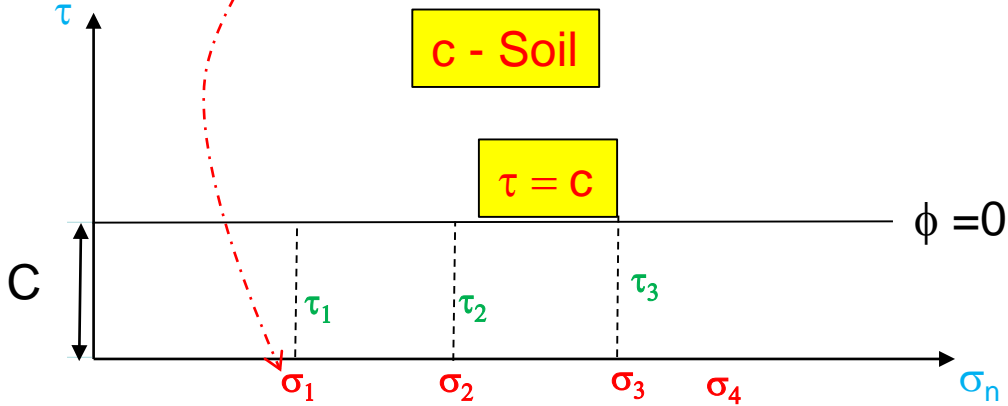

Example: Clay

II - Unconfined Compression Test

Unconfined Compression Test

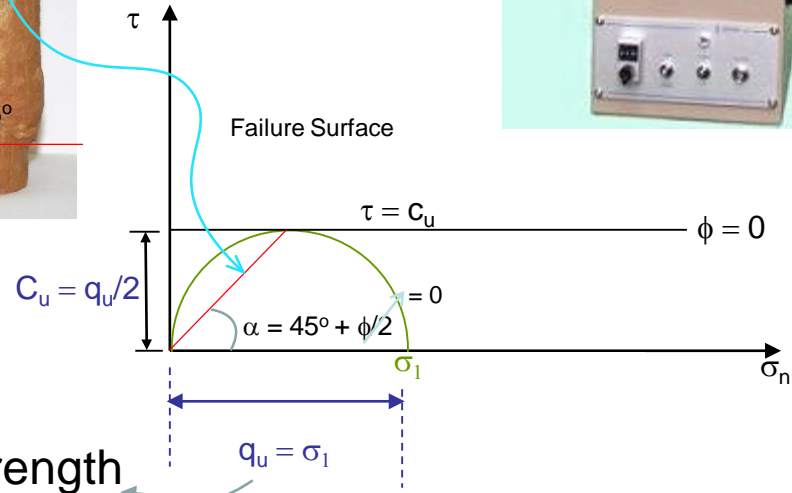
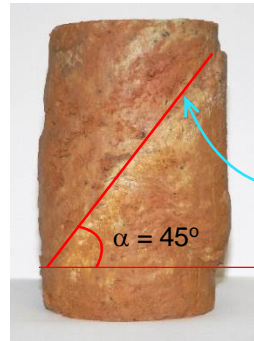
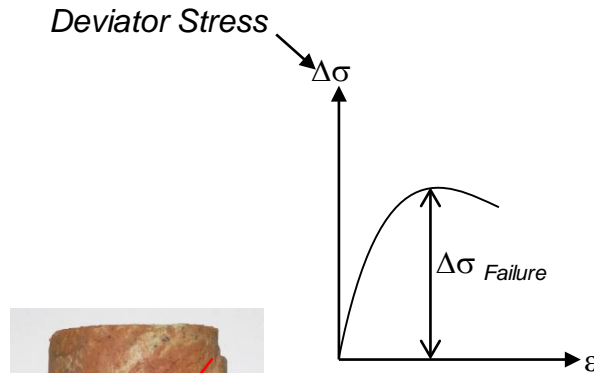
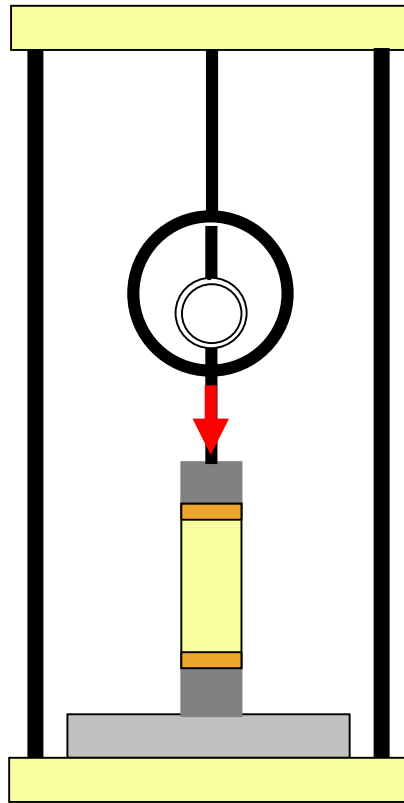

q_u = Unconfined compressive strength
 C_u = Unconfined shear strength
 $C_u = q_u/2$

Unconfined Compression Test

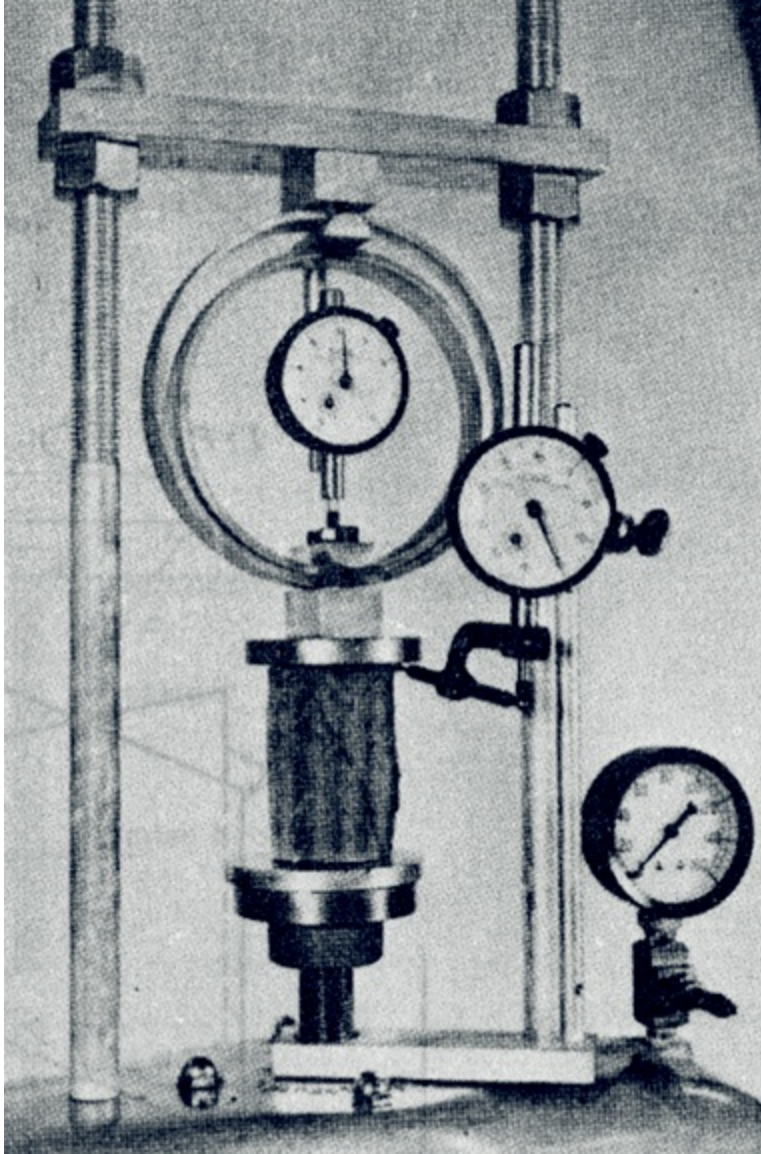

III - TRIAXIAL COMPRESSION TEST

TRIAxIAL COMPRESSION TEST

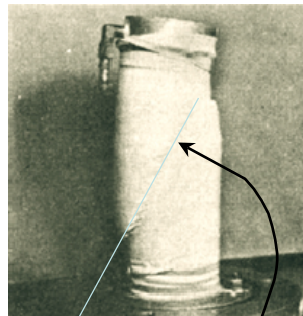

$$\alpha = 45^\circ + \phi/2$$

Failure Surface

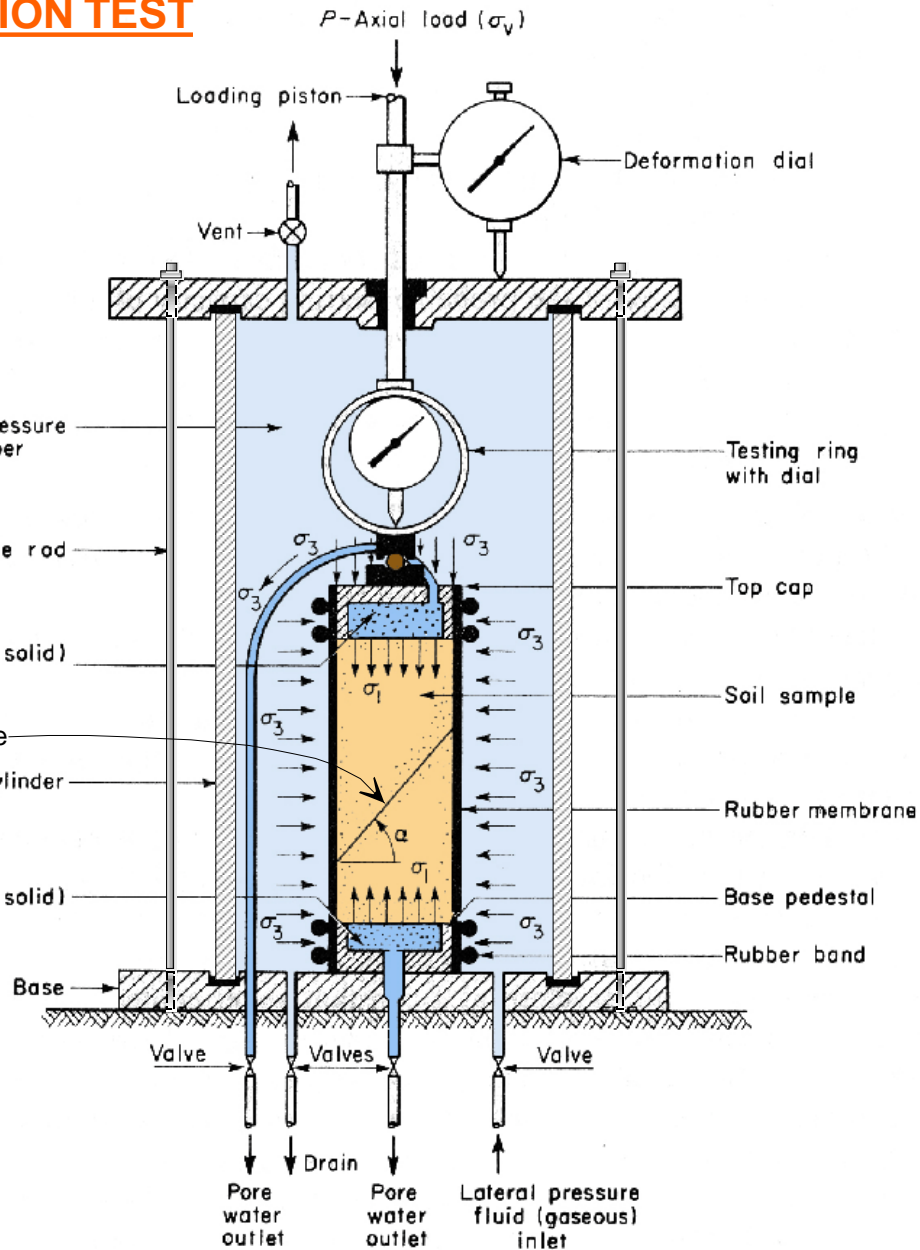

Triaxial Compression Test

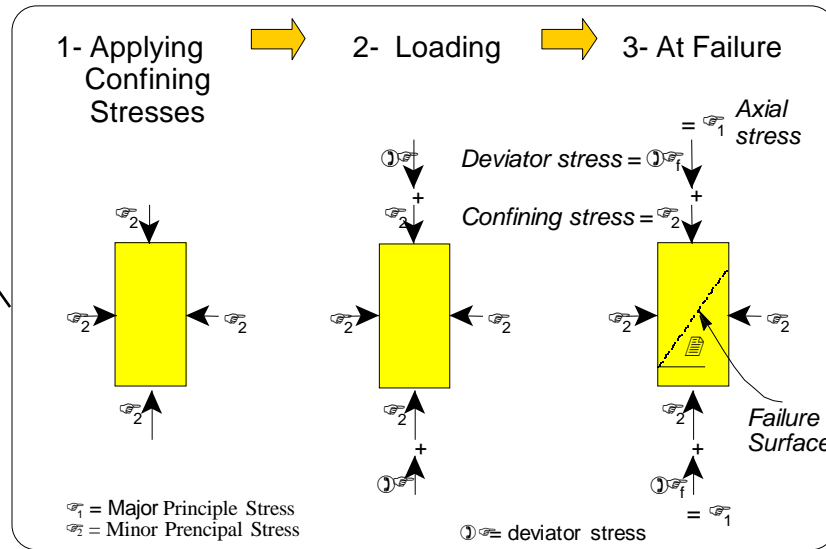

Each Circle = One Test

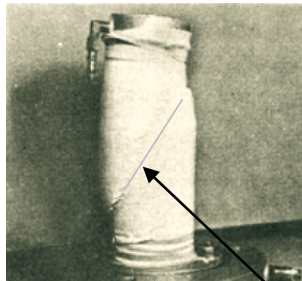

Failure Surface

Cohesion = C

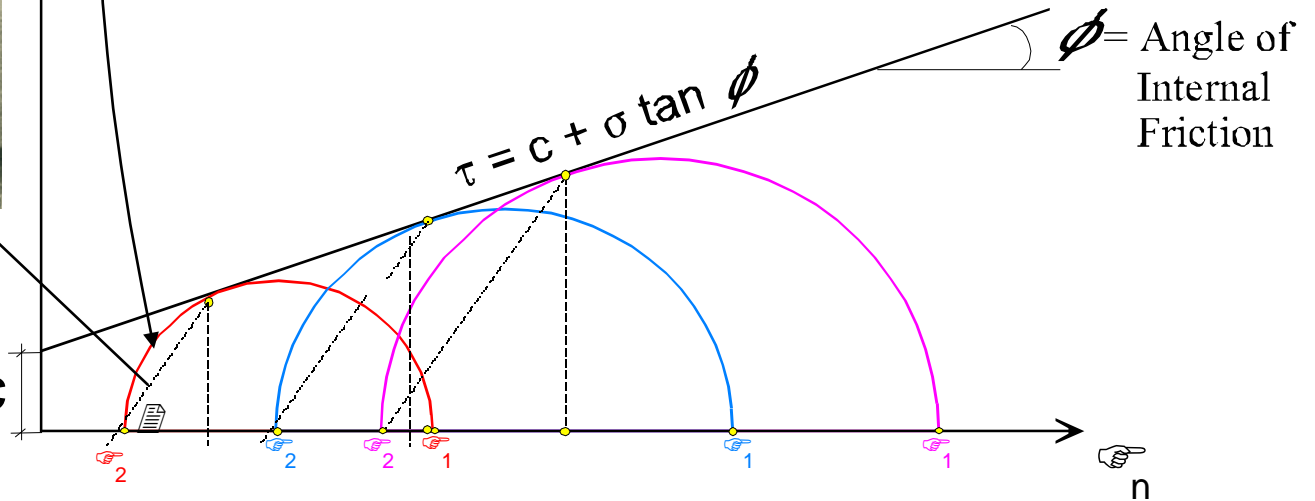

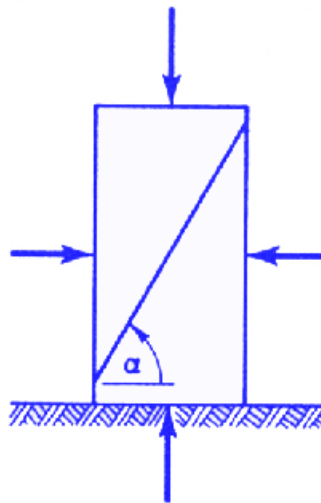
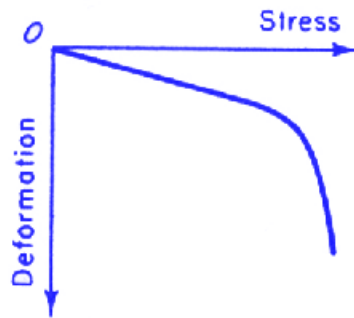

(a) Brittle, sharp failure with a clearly expressed shear plane.

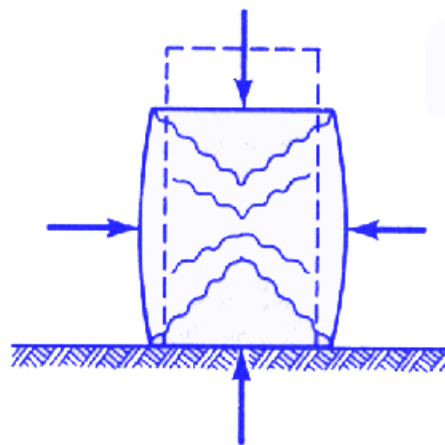
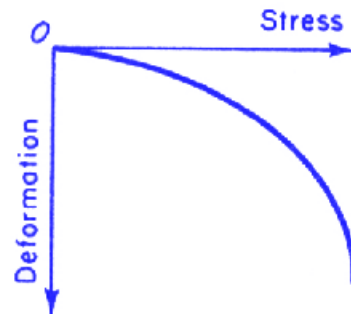

(b) Intermediate type of failure (shear cones and bulging).

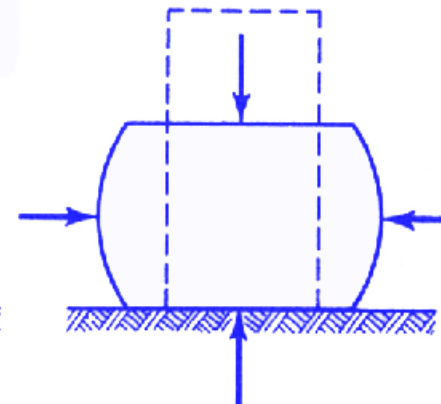

(c) Plastic failure with well-expressed lateral bulging.

Types of compression failures.

Triaxial Compression Test

1- Consolidated Undrained Test (CU)

Step 1

Step 2

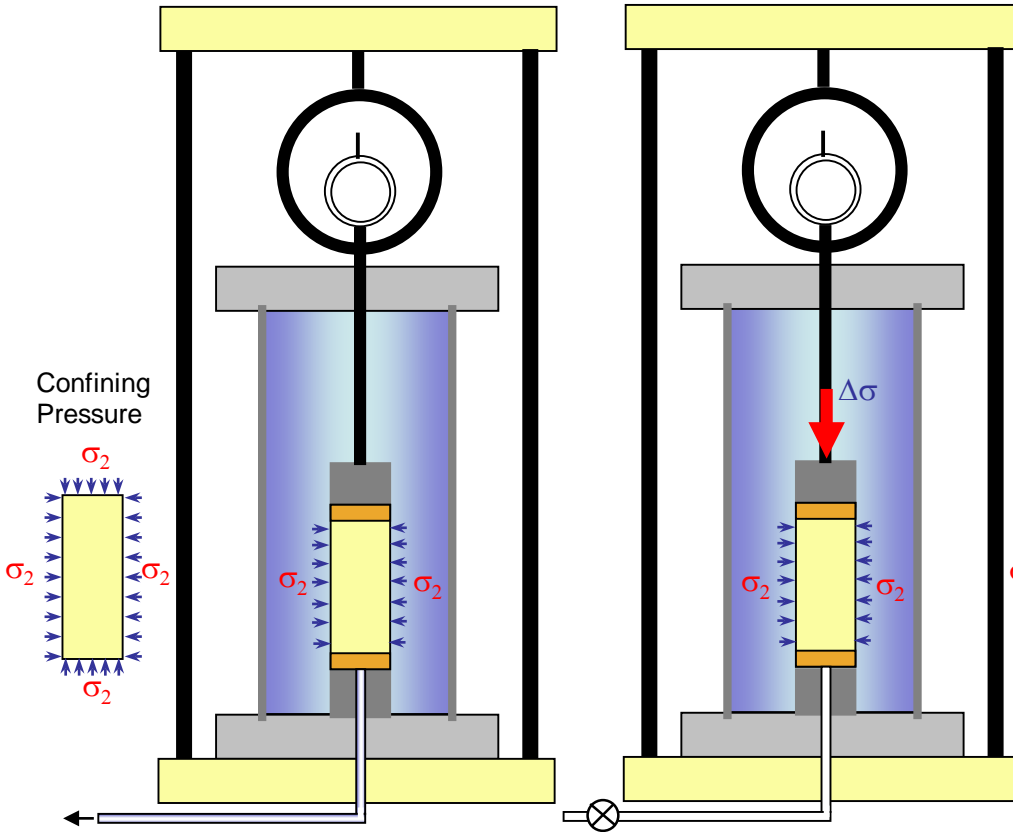

Deviator Stress

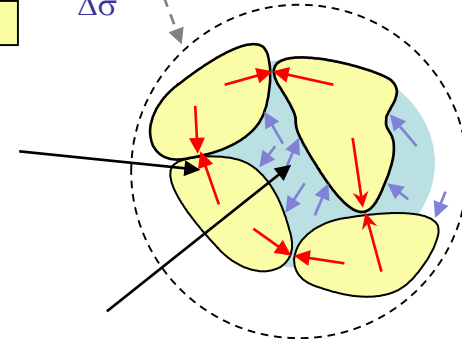
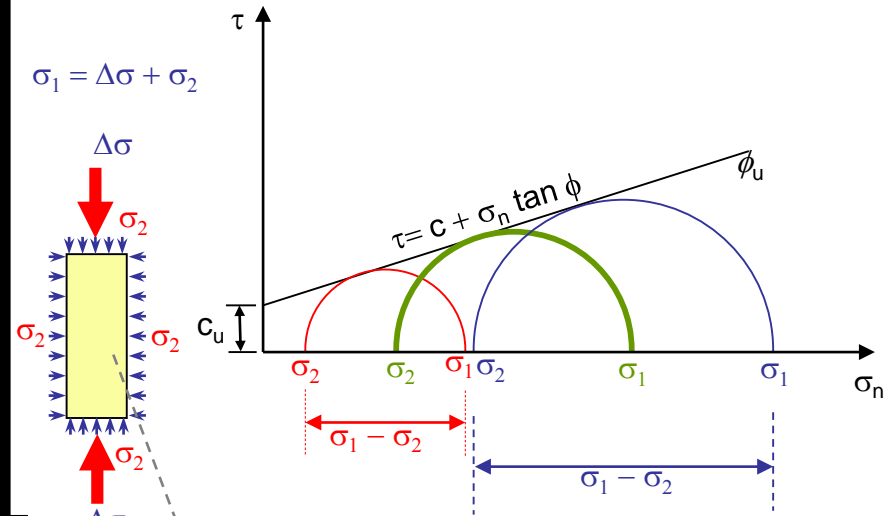
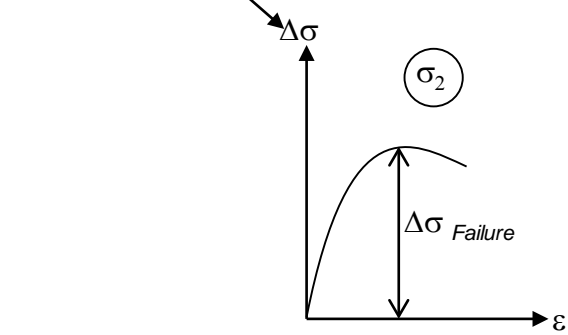

Triaxial Compression Test

2- Consolidated Drained Test (CD)

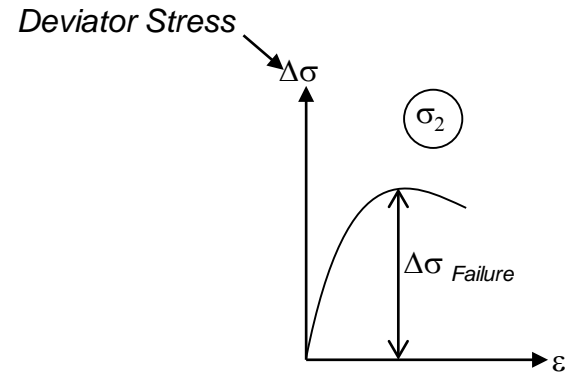
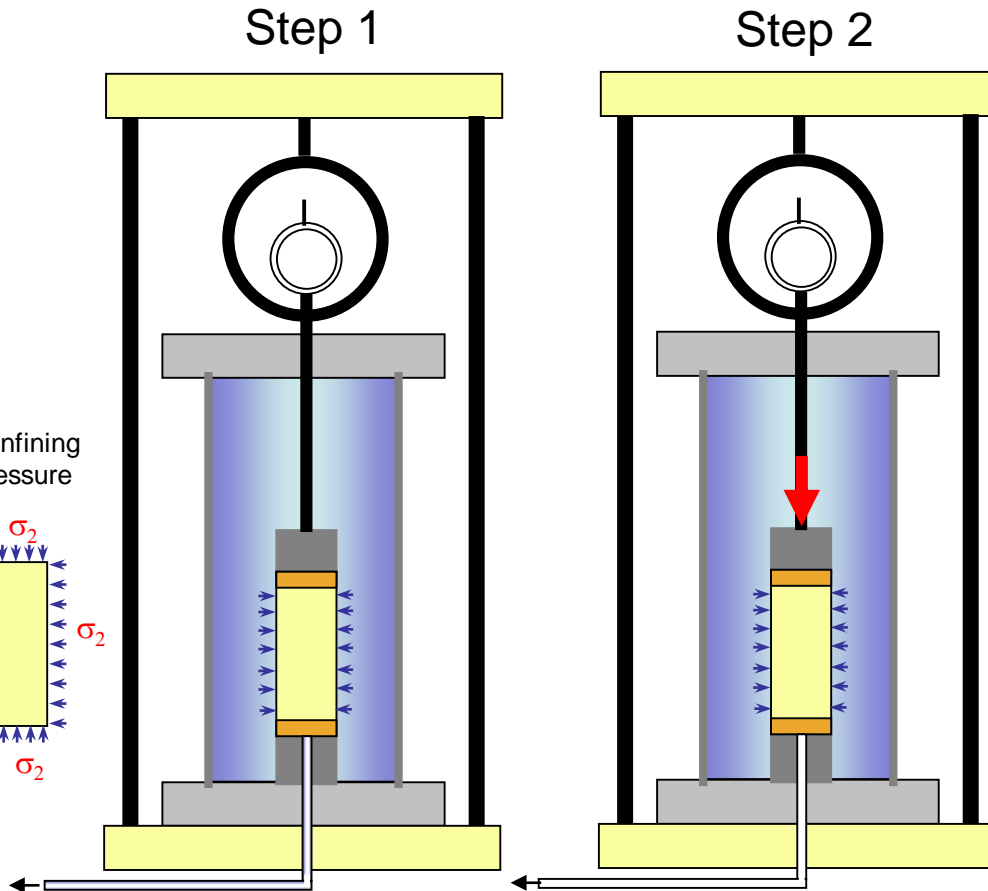

$$\sigma_1 = \Delta\sigma + \sigma_2$$

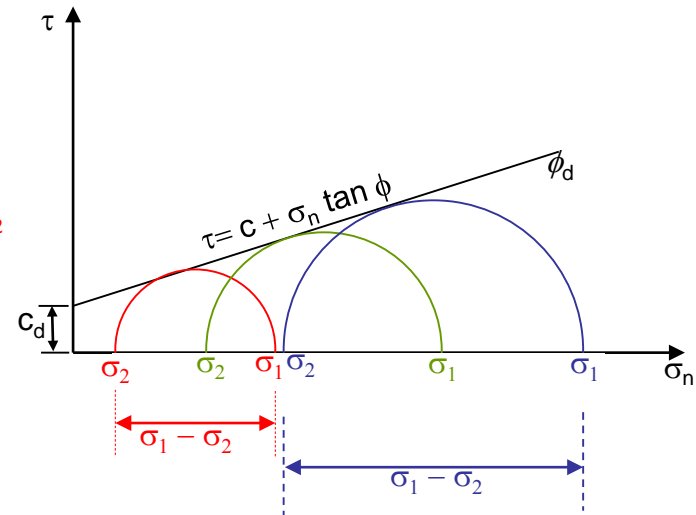
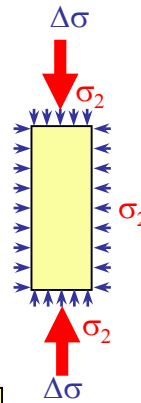

Triaxial Compression Test

3- Unconsolidated Undrained Test (UU)

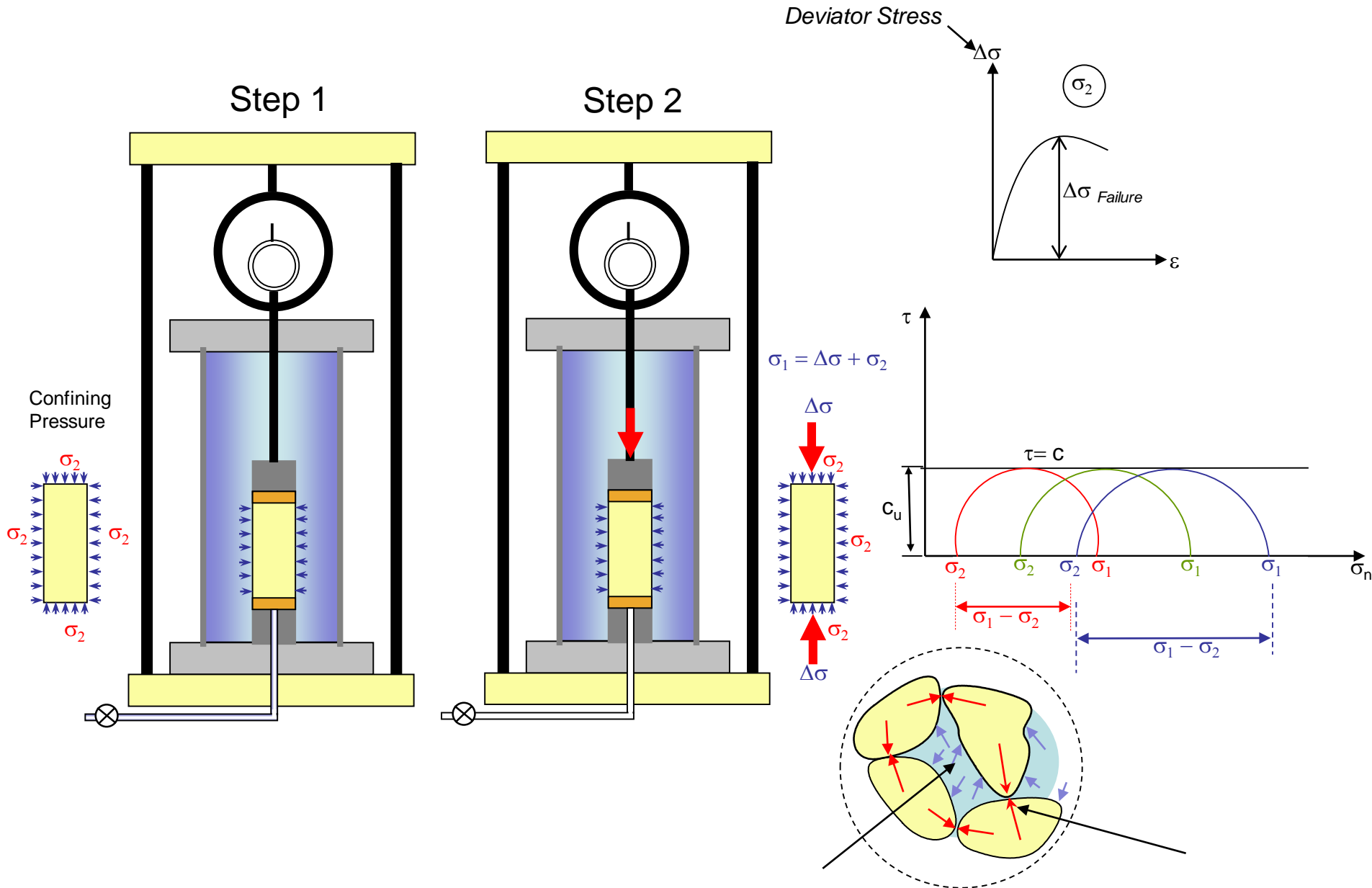

Triaxial Compression Test

Consolidated Undrained Compression Test

$$\sigma_{total} = \sigma_{eff} + \sigma_u$$

